

TriSensor user guide.

Modified on: Wed, 24 Mar, 2021 at 11:05 PM

Aeotec TriSensor.

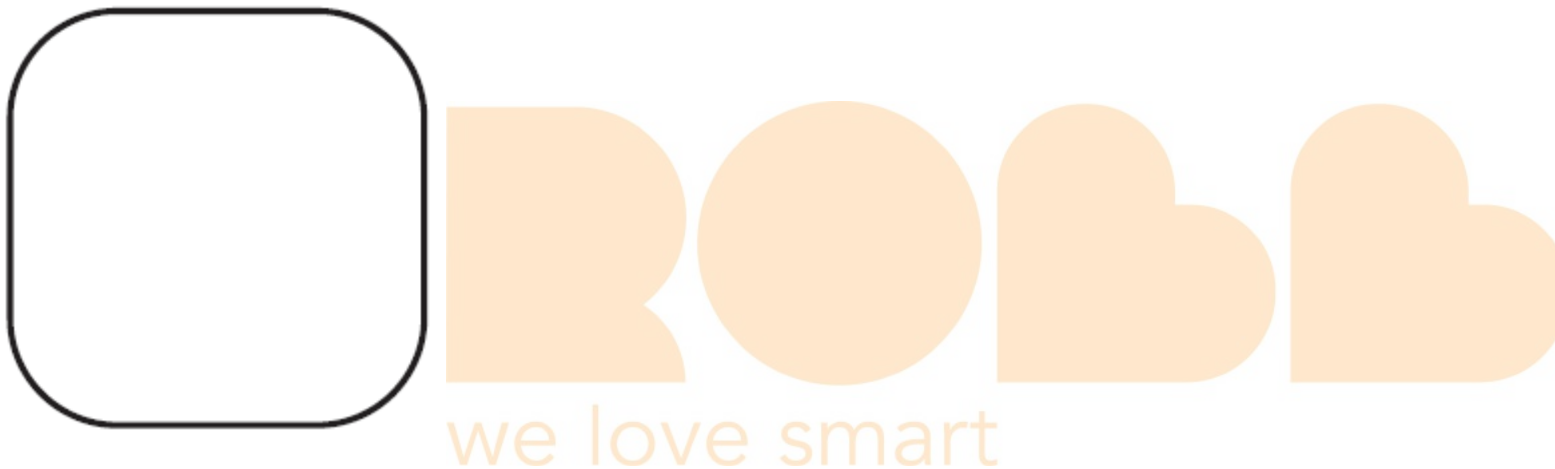

Aeotec TriSensor (<https://aeotec.com/z-wave-motion-sensor>) was developed to capture and transmit environmental values and motion via **Z-Wave Plus** (<http://aeotec.com/z-wave-plus>). It is powered by Aeotec's **Gen5** (<http://aeotec.com/z-wave-gen5>) technology. You can find out more about **TriSensor by following that link** (<https://aeotec.com/z-wave-motion-sensor>).

To see whether TriSensor is known to be compatible with your Z-Wave system or not, please reference our **Z-Wave gateway comparison** (<http://aeotec.com/z-wave-gateways>) listing. The **technical specifications of TriSensor** (<https://aeotec.freshdesk.com/solution/articles/6000195461-trisensor-technical-specification->) can be viewed at that link.

Get to Know your TriSensor.

Your TriSensor comes packaged with a number of accessories that will help with its installation and operation.

Package Contents:

1. TriSensor
2. 1x CR123A Battery (included)
3. Back-Mount Arm
4. Double-sided tape
5. 2x Screws
6. Battery included in TriSensor

Sensor Functions;

1. Motion
2. Temperature
3. Light

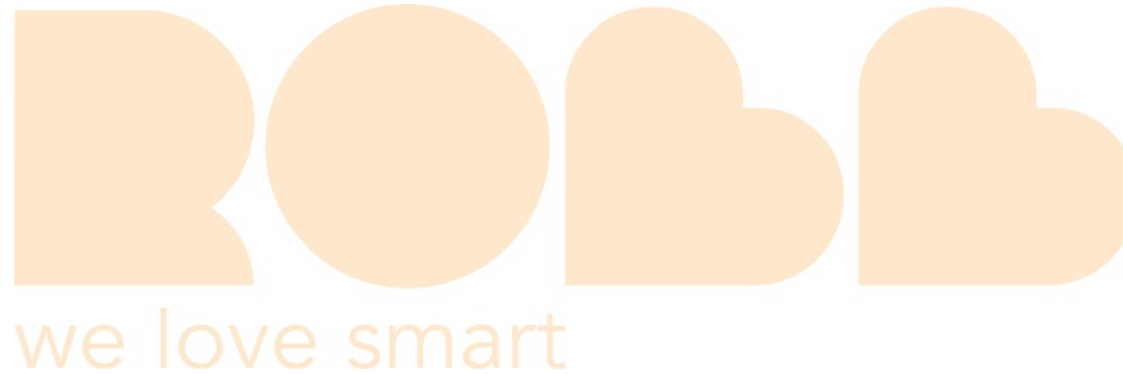

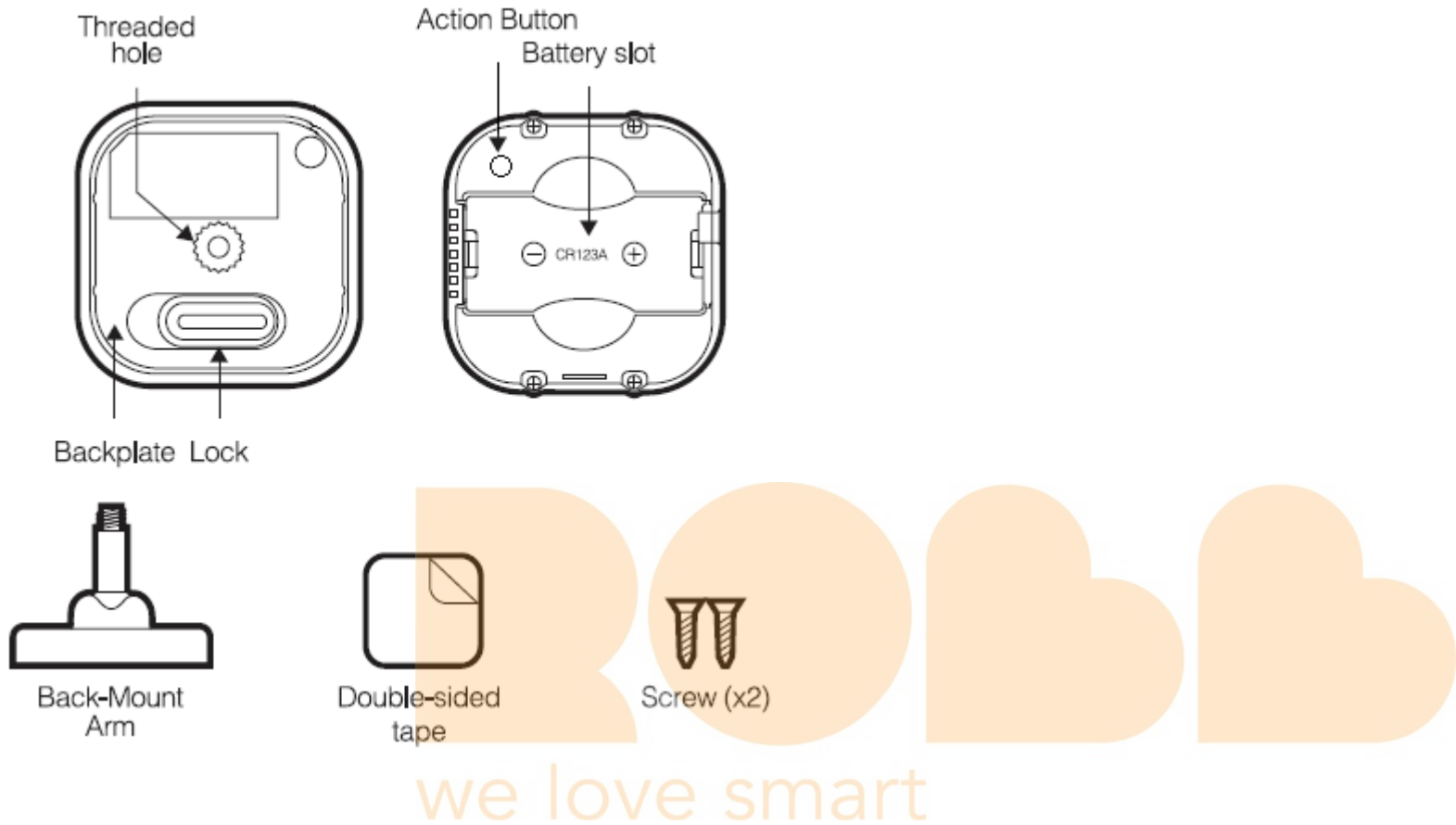

Button Presses.

Button Press	Function	LED Reaction	When Button is Released
Tap once (when unpaired).	Pair/Include	Yellow LED for 10 seconds.	Flashes green twice when successfully paired.
Tap once while gateway is in unpair mode.	Unpair/Remove	Purple LED for 2 seconds.	While LED when unpaired.
Tap once (when paired).	Send NIF	Purple LED for 2 seconds.	-
Press and hold for 2 seconds.	Wakeup Report	Red LED	Wakeup Report

Press and hold for 5 seconds.	Wakeup for 5 minutes	Yellow LED	Wakeup for 5 minutes
Press and hold for 9 seconds.	Health Test	Cyan LED	Health Test - Cyan LED flickers during health test, then blinks red, yellow, or green to determine direct connection to gateway health.
Press and hold for 15 seconds.	Factory Reset	Red LED	Factory Reset - Red LED flashes to confirm successful factory reset.

Important safety information.

Please read this and other device guides carefully. Failure to follow the recommendations set forth by Aeotec Limited may be dangerous or cause a violation of the law. The manufacturer, importer, distributor, and / or reseller will not be held responsible for any loss or damage resulting from not following any instructions in this guide or in other materials.

Keep product and batteries away from open flames and extreme heat. Avoid direct sun light or heat exposure. Always remove all batteries from products that are being stored and not used. Batteries may damage the appliance if they leak. Do not use rechargeable batteries. Ensure correct polarity when inserting the batteries. Improper battery use may damage the product.

TriSensor is intended for use in dry locations only. Do not use in damp, moist, and / or wet locations.

Contains small parts; keep away from children.

Quick Start.

Set Up Your Power.

TriSensor will be powered by battery. These steps can be performed in any location within your home, and not necessarily in your TriSensor's final installation location.

For a battery powered installation:

1. Remove your sensor's rear cover by sliding the lock to the right.
2. Pull out the CR123A battery and remove the plastic tab.
3. Place the CR123A battery back into its original position.



As soon as TriSensor is powered on, it will flash its red LED 4 times to indicate that it is now powered and ready to be paired.

Adding your TriSensor into a Z-Wave Network.

With it powered on, it's now time to add your TriSensor to a Z-Wave network. To pair TriSensor, you are not limited to only the Z-Stick or Minimote. You may use any Z-Wave Gateway to pair TriSensor, but compatibility and how the sensor shows ultimately depends on the gateway and software integration of products.

If you're using a Z-Stick from Aeotec:

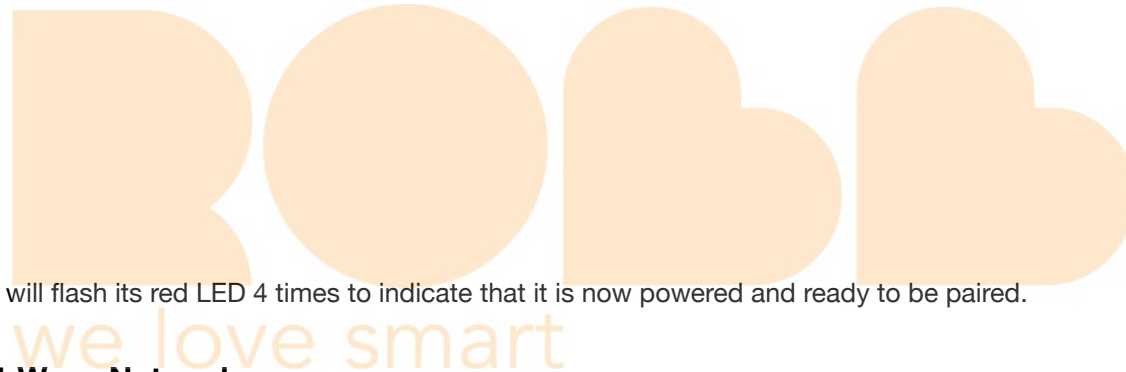

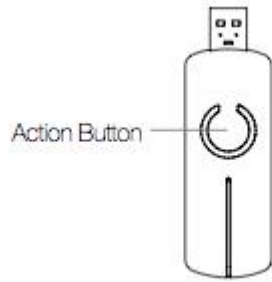

1. If your Z-Stick is plugged into a gateway or a computer, unplug it.
2. Take your Z-Stick to your TriSensor.
3. Press the Action Button on your Z-Stick. The LED will begin to blink the Blue LED slowly.
4. Press the Action Button on your TriSensor. The LED on TriSensor will blink white, then become a solid yellow LED, followed by a 2 flashes of white then green LED to indicate a successful inclusion. If the pairing process has failed, the LED will deactivate without flashing white or green.
5. You can test if your TriSensor has been successfully included into your Z-Wave network by pressing its Action Button. If you press the button and your sensor's purple LED is solid for a few seconds, then inclusion has been successful. If the yellow LED is solid when the button is pressed, the inclusion has been unsuccessful and you should repeat the steps from step 1.
6. Press the Action Button on the Z-Stick to return it to inclusion mode.

Return it to your gateway or computer.

If you're using a specific Z-Wave gateway you may need to refer to its user manual before proceeding:

7. Set your Z-Wave gateway or software to accept the Z-Stick as a Z-Wave Controller. Using your gateway or software, re-scan for new products if required, if it is not, the new devices recently added should automatically populate in your gateway/software interface.

If you're using an existing gateway (ie. Vera, Smartthings, ISY994i ZW, Fibaro, etc):

You may need to refer to your gateway's method of including devices if you do not know how to pair a Z-Wave device.

1. Put your primary Z-Wave gateway into pair mode, your Z-Wave gateway should confirm that it is waiting to add a new device
2. Press the Action Button on your TriSensor. The LED on TriSensor will blink white, then become a solid yellow LED, followed by a 2 flashes of white then green LED to indicate a successful inclusion. If the pairing process has failed, the LED will deactivate without flashing white or green.
3. You can test if your TriSensor has been successfully included into your Z-Wave network by pressing its Action Button. If you press the button and your sensor's purple LED is solid for a few seconds, then inclusion has been successful. If the yellow LED is solid when the button is pressed, the inclusion has been unsuccessful and you should repeat the steps from step 1.

Choosing a Location for your TriSensor.

TriSensor can bring its intelligent readings to many locations of your home. Before deciding on a location, there are some things you should first consider.

TriSensors motion sensor uses light and heat readings to determine motion; sudden light and heating changes can impact the sensor's quality of motion readings. As such, your sensor should not be installed in areas of artificial temperature change. Thus, when selecting a location, avoid placing it beside or near air conditioners, and heaters.

Your TriSensor will be powered by batteries, you should avoid installing it in a location where the temperature can drop below 0°C / 32°F - this is below the any battery operational use point. Selecting a location for your sensor also depends on the layout of any area that you want monitored. Whatever the room or area, please ensure that it fits with your sensor's effective motion sensing range as described in the following diagrams.

we love smart

For optimal performance, your TriSensor should NOT be mounted directly on or near metal framing or other large metallic objects. Large metal objects may weaken the Z-Wave wireless signal TriSensor depends on for communication due to the wireless reflective properties of metal.

TriSensor maximum motion detection range is: 23ft or 7m.

Outdoor installation.

Please note that when installed outdoors of your home, your TriSensor should only be relied on for temperature and light where as the motion sensing capabilities should be disabled on your gateway in order to avoid false motion readings. If selecting an outdoor location, it's important to position your TriSensor in a sheltered location. It is best if your TriSensor is not directly exposed to rain, snow, or other elements.

If you wish to use TriSensor outdoors, you will need to lower settings, and angle TriSensor accordingly as all environments will require different solutions or different settings for the motion sensor to work properly. Parameter 3 [1 byte] will determine the sensitivity of the motion sensor from a value range of 0 disabled to 11 max sensitivity (your ability to configure this setting will depend on the gateway used).

It is advised that if you are seeing false motion tracking, run trial and error to determine the best sensitivity from a range of 0 - 11 by going down 1 sensitivity level after every test (first 5, 4, 3, 2, then 1), while setting Parameter 3 [2 byte] to 5 to allow a PIR sensor timeout of 5 seconds after detecting motion to rapidly determine the best settings for motion use outdoors.

Physically install your TriSensor.

With your TriSensor now a part of your Z-Wave network and having determined its installation location, it's time to finish its physical installation. There are 2 ways that your TriSensor can be mounted on a wall or ceiling. Most simply it can be placed upon a shelf without the need to attach further accessories. You can mount your sensor in a corner or against a wall or ceiling by using the Back-Mount Plate. It's also possible to embed your TriSensor within a ceiling or wall using its Recessor accessory (sold separately).

To install your TriSensor;

Reattach the three parts of your TriSensor to each other. Unlock the Battery Cover from the Sensor unit.

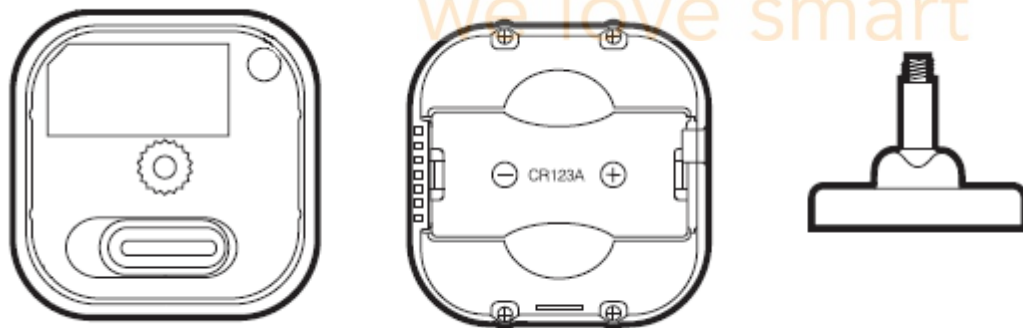

You may also install your TriSensor on any flat surface area such as tables, and bookshelves;

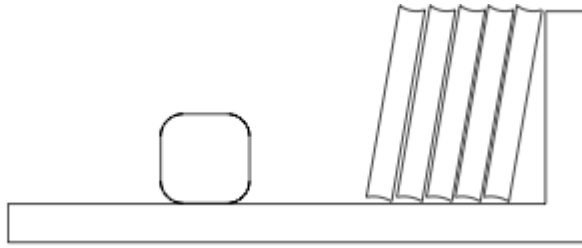

You can place it upon a shelf without the need to attach further accessories.

To install your TriSensor with the Back-Mount Plate;

1. You can affix the Back-Mount Arm by Double-Sided Tape or using the provided KA2.5×20 mm screws.

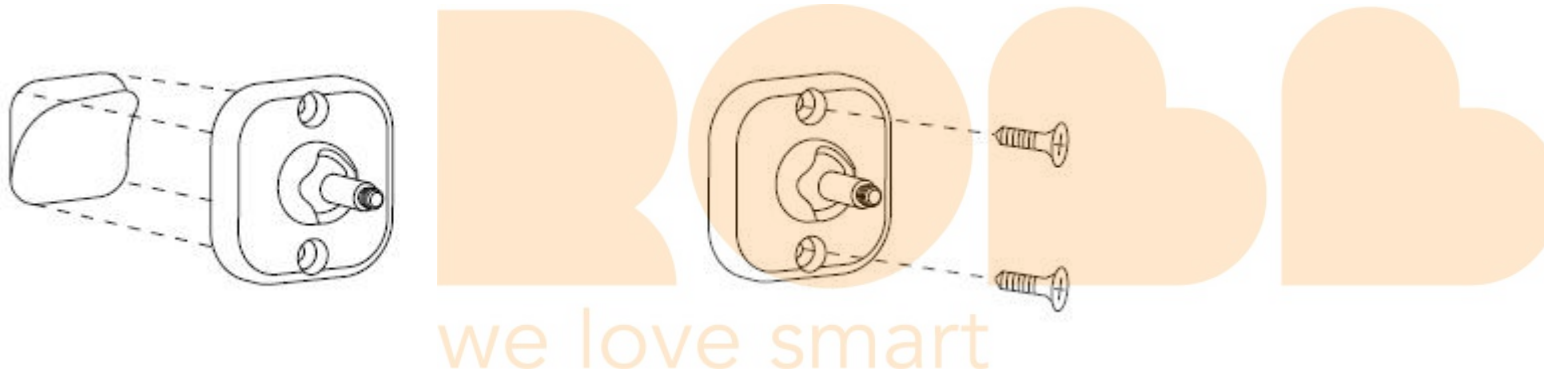

Tips: We suggest you choose the second method (using screws to affix the Back-Mount Arm) which would be more stable.

2. After you have completed the affixing of Back-Mount Arm, you will need to lock TriSensor to the Back-Mount Arm by screwing TriSensor in.

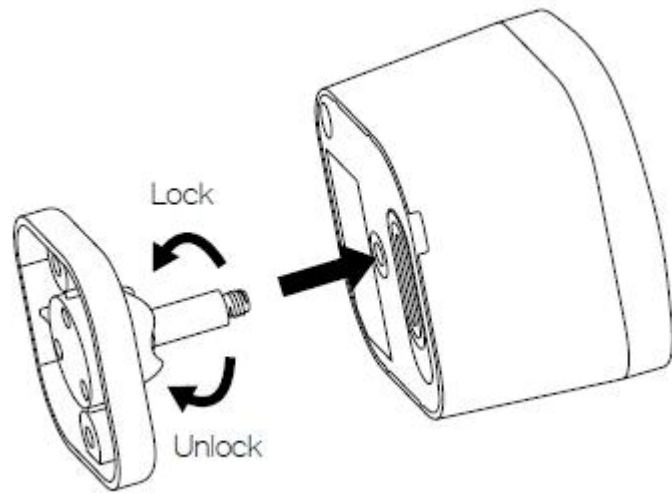

3. The Back-Mount Arm may be locked at various angles by turning the Friction Lock clockwise and counter-clockwise to respectively tighten or loosen the angle of the arm. You can rotate the Friction Lock to change the measurement area of sensor.

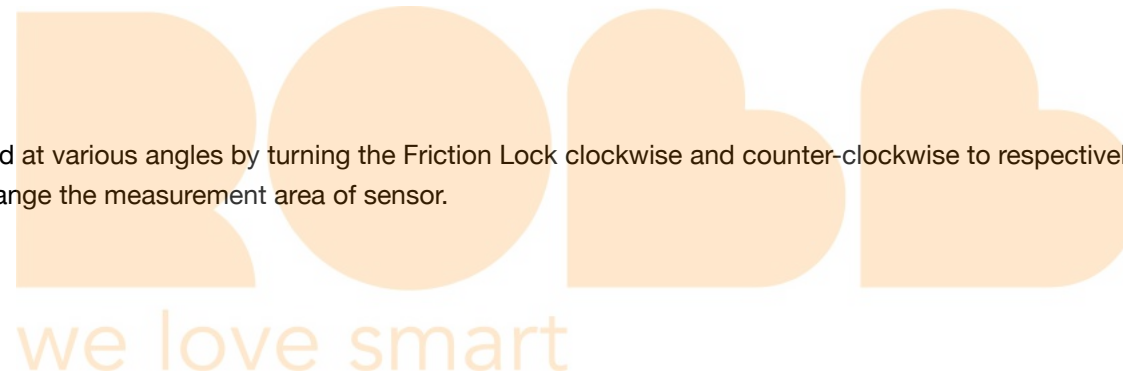

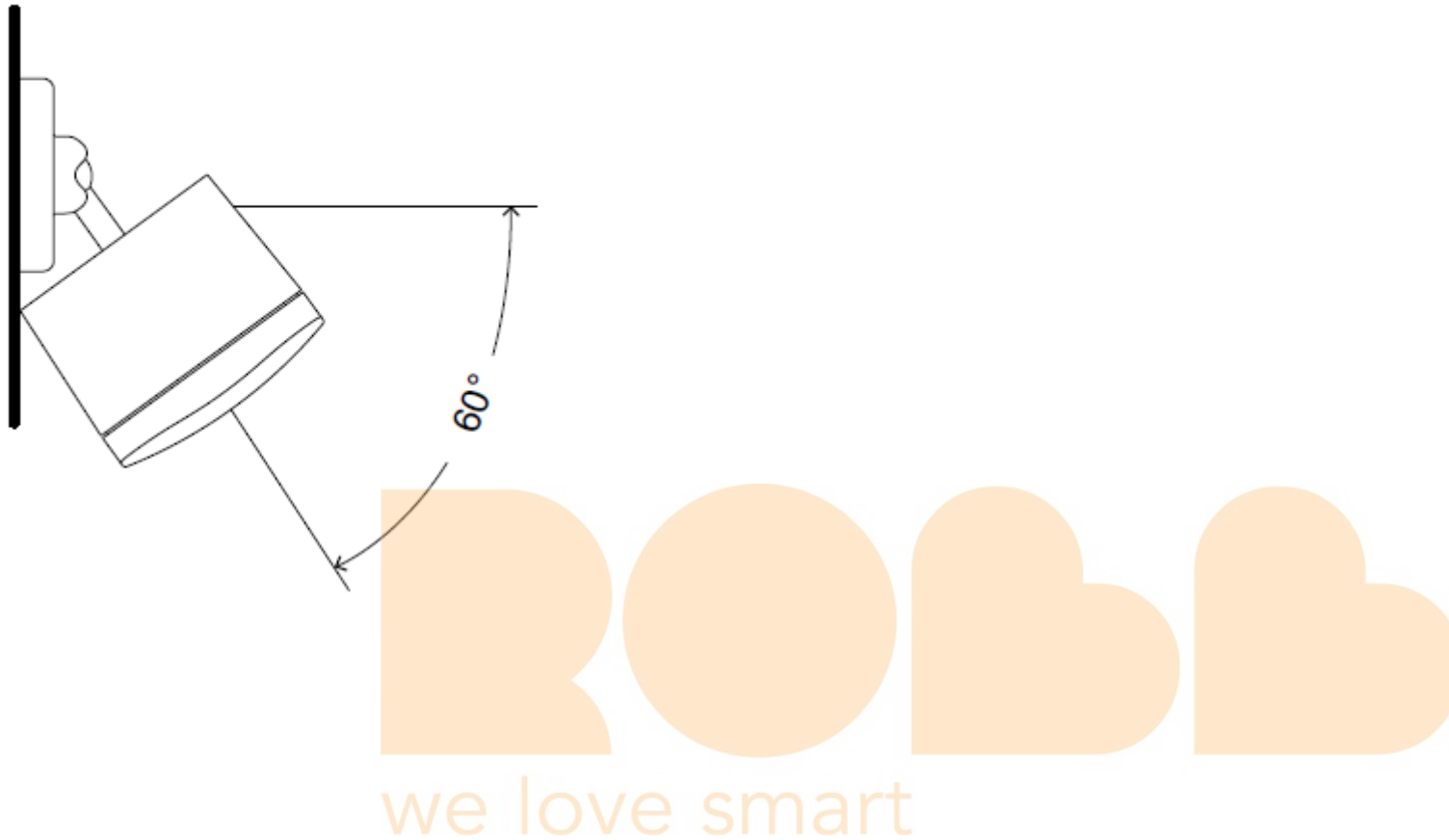

Advanced Functions.

Battery Reporting.

Your TriSensor has built in battery level detection. It will automatically report its battery level to the associated controller/gateway throughout its life until the battery is fully drained and needs replacing. The battery status will often be displayed in the user interface of the controller/ gateway. When used properly in an optimized Z-Wave network, your TriSensor can be powered by batteries for 24 months before battery replacement is necessary.

Recommendation: For networks which do not offer a method to display

For the battery level of your TriSensor, it is recommended that the sensor be tested occasionally to ensure that the batteries still hold enough charge to operate. Batteries naturally lose their charge over time.

Battery reports and when they come.

There are a few ways to update your battery status.

1. Polling
2. Battery GET command
3. Automatic Wakeup Notification Report

The most optimized method is to wait for TriSensor to Wakeup and send the battery report during this time. In order to poll or send a Battery GET command to TriSensor, this sensor will need to report a Wakeup Report to your gateway.

By default, Wakeup Report will be sent at an interval of once every 8 hours as well as its Battery Report.

Waking up TriSensor manually.

During TriSensors normal use, TriSensor will remain in a sleeping state to conserve battery power and will continue to detect motion and report sensors to your gateway, TriSensor needs to be awake or in an active state in order to take in new configurations or commands. There are 2 methods of waking up TriSensor to take in new commands from your Z-Wave gateway.

Forward wakeup report command (momentarily wake up TriSensor).

Forwarding a wakeup report to your gateway is a good way for TriSensor to take in queued commands from your gateway. If your gateway queues commands to battery devices, you can queue as many commands for TriSensor then perform this step to take in all of the commands at once.

1. Remove TriSensors battery cover (by unlocking then removing the cover)
2. Press and hold TriSensors Action Button until LED turns red. (2 seconds of holding)
3. Release TriSensors button.

Keep TriSensor awake for 5 minutes.

Keeping your TriSensor awake is a good way to send in commands one by one from your gateway as you are able to with plugin Z-Wave devices that are always active. This is good for gateways that do not queue commands for you and require immediate action.

1. Remove TriSensors battery cover (by unlocking then removing the cover)
2. Press and hold TriSensors Action Button until LED turns yellow. (5 seconds of holding)
3. Release TriSensors button.

If you were successful in keeping TriSensor awake, its yellow LED will remain solid up to 5 minutes. If your gateway sends a NO MORE INFORMATION command back, this will instantly put your TriSensor back to sleep right away (so if you see that yellow LED immediately disappeared, this is exactly what is happening).

You can manually put TriSensor back to sleep by tapping its button once.

Typically your TriSensor will automatically wake up once every 8 hours by default automatically.

Testing Health Connectivity.

Note - Health test does not test for routing communication health, only tests for direct communication with your gateway to determine if it has a healthy direct connection.

You can determine the health of your TriSensors connectivity to your gateway using a manual button press, hold, and release function which is indicated by the LED color.

1. Remove TriSensors battery cover. (by unlocking then removing the cover)
2. Press and hold TriSensors Action Button until LED turns cyan/blue color. (9 seconds of holding)
3. Release TriSensors button.
4. TriSensor will enter health communication test mode by flickering its cyan/blue LED, this will go on for about 2 minutes.
5. LED will then change to a solid color for 2 seconds to indicate its health and communication to your gateway/controller (1 of 3 colors):

Red = Bad Health

Yellow = Moderate Health

Green = Great Health

Manually Factory Reset TriSensor.

This method is not fully advised unless your gateway has failed, and you do not yet have another gateway to perform a general unpair on TriSensor.

1. Press and hold TriSensor Action button

2. Wait until the RGB LED turns from:

- Red
- Orange
- Cyan
- Red LED flashes 5 times which will indicate a factory reset.

3. If your TriSensor has been successfully factory reset from its previous network, the LED will become a solid yellow when you tap its Action Button. If this has failed, the LED will become a solid purple color for 2 seconds when you tap the Action Button.

Removing your TriSensor from Z-Wave Network.

Your TriSensor can be removed from your Z-Wave network at anytime. You'll need to use your Z-Wave network's main controller to do this and the following instructions tell you how to do this.

If you're using a Z-Stick:

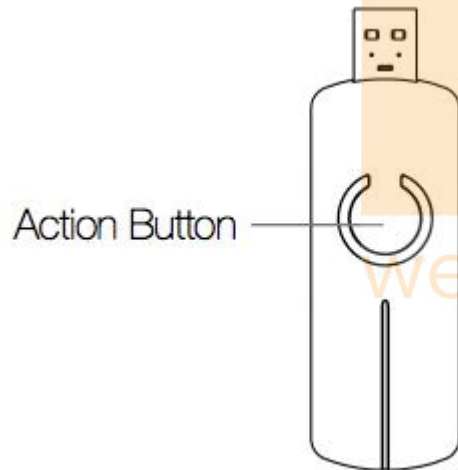

1. If your Z-Stick is plugged into a gateway or a computer, unplug it.
2. Take your Z-Stick to your TriSensor.
3. Press and hold the Action Button on your Z-Stick for 3 seconds and then release.
4. Press the Action Button on your TriSensor once. The LED on TriSensor will become a solid purple color.

5. If your TriSensor has been successfully removed from your network, the LED will flash white, green, white, green (white, then green 2x times).
6. Press the Action Button on the Z-Stick to take it out of removal mode.

If you're using an existing gateway:

You may need to refer to your gateway's method of including devices if you do not know how to pair a Z-Wave device. You may use any gateway to perform an unpair/removal on TriSensor even if they are not paired together to factory reset TriSensor.

1. Put your primary Z-Wave gateway into unpair mode, your Z-Wave gateway should confirm that it is waiting to remove a device
2. Press the Action Button on your TriSensor 3x times within 2 seconds. The LED on TriSensor will become a solid purple color.
3. If your TriSensor has been successfully removed from your network, the LED will flash white, green, white, green (white, then green 2x times).

Advanced configurations for TriSensor.

You may also view our engineering sheet for TriSensor here: <https://aeotec.freshdesk.com/helpdesk/attachments/6064224662>
(<https://aeotec.freshdesk.com/helpdesk/attachments/6064224662>).

Monitoring motion.

When TriSensor detects a motion event it will automatically send a notification report to Group 1 which is usually automatically set to report to your gateway upon pairing your TriSensor.

Command Class	COMMAND_CLASS_NOTIFICATION
Command	NOTIFICATION_REPORT
Type	HOME_SECURITY (0x07)
Event	HOME_SECURITY_MOTION_DETECTION_UNKNOWN_LOCATION (0x08) / HOME_SECURITY_NO_EVENT (0x00)

By default, your sensor will time out after 240 seconds, for better use as a presence sensor, you can retrigger the motion sensor to reset its timeout back to 240 seconds after 30 seconds. These settings are configurable.

1. Motion re-trigger time.

This configures the delay time before you can retrigger the PIR sensor, if the re-trigger happens between retrigger time and clear time, this will reset the clear time clock. If this is disabled, you must wait until motion clears to trigger motion again.

This setting is used as a presence sense and works together with Parameter 2. This will also help with conserving battery report as if you re-trigger before clear time ends, TriSensor will not send a report.

Parameter #	Size	Value	Description
1	2	0	Disable Motion Re-Trigger.
		1-32767	Delay time in seconds.

DEFAULT SETTING = 30

2. Motion clear time.

This configures the clear time when your motion sensor times out and sends a no motion status.

Parameter #	Size	Value	Description
2	2	1-32767	Clear/timeout time in seconds.

DEFAULT SETTING = 240

3. Motion sensitivity.

This setting configures the sensitivity of Motion Sensor where 0 is disabled, 1 is lowest sensitivity, and 11 is maximum sensitivity.

Parameter #	Size	Value	Description
3	1	0-11	Sets motion sensitivity.

DEFAULT SETTING = 11

4. Enable/Disable Binary Sensor

This setting is used to enable Binary Sensor Reports which is used for gateways that use the older style of motion reports. If you do not see status changes over your motion sensor, you must enable this setting.

Command Class	COMMAND_CLASS_SENSOR_BINARY
Command	SENSOR_BINARY_REPORT
Type	MOTION (0x0C)
Event	Detected (0xFF) / No-detected (0x00)

Parameter #	Size	Value	Description
4	1	0	Disables Binary Sensor Report
		1	Enables Binary Sensor Report

DEFAULT SETTING = 0

Group Association for direct control.

The TriSensor has 2 group control points to directly control Z-Wave devices without your gateway. Below is a table of the available Group Association that you can set to the TriSensor to directly control your Z-Wave Switches and Dimmers from within your gateway.

Group Association #	Function
2	Motion Trigger = turn on device No Motion Trigger = turn off device.
3	Temperature > Threshold = turn on device. Temperature <= Threshold = turn off device.

What is a Group Association?

A Group Association is a specific function in Z-Wave that allows you to tell the TriSensor who it can speak to. Some devices may only have 1 group association meant for the gateway, or multiple group associations that can be used for specific events. This type of function isn't used too often, but when it is available, you may be able to use it to directly communicate to Z-Wave devices instead of controlling a scene within a gateway which can have unforeseen delays.

Vera has the ability to set Group Associations to devices that have these special events and functions. In TriSensor case, it can speak directly to the devices it is associated to for directly toggling On/Off controls via temperature or motion sensor triggers without communicating to your gateway.

For example:

- Using Group associations will talk directly to a Z-Wave device, this will process less than 1 second usually within 10-100ms.
- Triggering a scene, a device will need to update its status to your gateway, then have the gateway process the status update then send an action or change to a Z-Wave device based on the trigger. Sometimes there may be delays if your gateway is already processing other data which can cause 1-2 second delays from time to time.

How many devices you can control.

You can control 5 devices per Group Association for a total of 10 separate devices per button over 2 different Group Associations

Example;

- 5 devices on Group 2 (motion sensor control)
- 5 devices on Group 3 (temperature sensor control)

How do I control my devices using group association?

This is a bit difficult as many gateways provide this function and just as many gateways will not provide an option to program this. You'll need to look into your gateways functions and see if they support "Group Association" and how to do it.

5. Enable or disable Group 2 or 3 group association for direct control.

This parameter is configured the enabled or disabled send BASIC_SET command to nodes that associated in group 2 and group 3.

Parameter #	Size	Value	Description
5	1	0	Disabled All Group Basic Set Command
		1	Enabled Group 2 Basic Set Command, Group 3 Basic Set Command is disabled.
		2	Enabled Group 3 Basic Set Command, Group 2 Basic Set Command is disabled.
		3	Enabled Group 2 and Group 3 Basic Set Command.

DEFAULT SETTING = 3

6. Basic Set controls for Group 2.

This setting gives you more control as to how Group 2 is controlled by your motion sensor.

Parameter #	Size	Value	Description
6	1	0	Send BASIC_SET = 0xFF to devices associated in Group 2 when motion event is triggered, send BASIC_SET = 0x00 to devices associated in group 2 when motion event is cleared.
		1	Send BASIC_SET = 0x00 to devices associated in Group 2 when motion event is triggered, send BASIC_SET = 0xFF to devices associated in group 2 when motion event is cleared.
		2	Send BASIC_SET = 0xFF to devices associated in Group 2 when motion event is triggered.
		3	Send BASIC_SET = 0x00 to devices associated in Group 2 when motion event is triggered.
		4	Send BASIC_SET = 0x00 to devices associated in Group 2 when motion event is cleared.
		5	Send BASIC_SET = 0xFF to devices associated in Group 2 when motion event is cleared.

DEFAULT SETTING = 0

7. Temperature Alarm Setting (Group 3 control).

This parameter is configured the threshold value that alarm level for temperature. When the current ambient temperature value is larger than this configuration value, TriSensor will send a BASIC_SET = 0xFF to nodes associated in group 3. If current temperature value is less than this value, device will send a BASIC_SET = 0x00 to nodes associated in group 3.

This setting is great for the control of Air Conditioners.

Parameter #	Region	Size	Value	Default
7	EU/AU	2	-400 - 850	239 C
	US	2	-400 - 1185	750 F

LED control settings.

You can control what colors the LED blinks when certain events happen for: Motion, Temperature, Light, Battery, and Wakeup.

10. Enable or Disable LED over TriSensor

This completely disables all LED reaction, this will affect Parameter 11 - 15 settings.

Parameter = 10

Size = 1 Byte

Values and description;

0 = Disable LEDs

1 = Enable LEDs *[Default]*

11. Motion report LED.

This setting changes the color of the LED when your TriSensor sends a motion report. (*This parameter is used only if Parameter 10 is set to 1/enable).

Parameter #	Size	Value	Description
11	1	0	Disable
		1	Red
		2	Green [Default]
		3	Blue
		4	Yellow
		5	Pink
		6	Cyan
		7	Purple
		8	Orange

12. Temperature report LED.

This setting changes the color of the LED when your TriSensor sends a temperature report. (*This parameter is used only if Parameter 10 is set to 1/enable).

Parameter #	Size	Value	Description
12	1	0	Disable [Default]
		1	Red
		2	Green

	3	Blue
	4	Yellow
	5	Pink
	6	Cyan
	7	Purple
	8	Orange

13. Light report LED.

This setting changes the color of the LED when your TriSensor sends a light report. (*This parameter is used only if Parameter 10 is set to 1/enable).

Parameter #	Size	Value	Description
13	1	0	Disable [Default]
		1	Red
		2	Green
		3	Blue
		4	Yellow
		5	Pink
		6	Cyan
		7	Purple
		8	Orange



14. Battery report LED.

It is possible to change the color of what the LED blinks when your TriSensor sends a battery report. (*This parameter is used only if Parameter 10 is set to 1/enable).

Parameter #	Size	Value	Description
14	1	0	Disable [Default]
		1	Red
		2	Green
		3	Blue
		4	Yellow
		5	Pink
		6	Cyan
		7	Purple

	8	Orange
--	---	--------

15. Wakeup report LED.

This setting changes the color of the LED when your TriSensor sends a wakeup report. (*This parameter is used only if Parameter 10 is set to 1/enable).

Parameter #	Size	Value	Description
15	1	0	Disable [Default]
		1	Red
		2	Green
		3	Blue
		4	Yellow
		5	Pink
		6	Cyan
		7	Purple
		8	Orange

Temperature controls.

20. Temperature Scale Setting.

You can control what scale is reported from your temperature sensor.

Parameter #	Region	Size	Value	Default
20	EU/AU	1	0 - 1	0
	US	1	0 - 1	1

Value and Description;

0 = Celcius

1 = Fahrenheit

21. Temperature Threshold reporting.

Change threshold value for change in temperature to induce an automatic report for temperature sensor. Scales with Parameter 64 change to C or F. Setting of value 20 can be a change of -2.0 or +2.0 (C or F depending on Parameter 64) to induce automatic report or setting a value of 2 will be a change of 0.2(C or F).

Parameter #	Size	Value	Description
-------------	------	-------	-------------

21	2	0	Disable Threshold Report for Temperature Sensor
		1 - 250	Sets threshold for inducing automatic report using a scale of 0.1 * value = temperature threshold

23. Temperature automatic report based on time.

This parameter is configured the time interval for temperature sensor report. This value is larger, the battery life is longer.

Parameter #	Size	Value	Description
23	2	1-32767	Automatic report set in seconds.

DEFAULT = 3600

30. Temperature Offset Value.

The current measuring temperature value can be offset by a + and - a value by this setting. The scale can be decided by Parameter Number 14.

Temperature Offset Value = [Value] * 0.1(Celsius / Fahrenheit)

Parameter #	Size	Value	Description
30	2	-200 - 200	Offset Value.

DEFAULT = 0

Light Sensor controls.

22. Light Threshold Report

Change threshold value for change in light sensor to induce an automatic report for temperature sensor.

Scale: Lux

Parameter #	Size	Value	Description
22	2	0	Disable Threshold Report for Temperature Sensor
		1 - 10000	Sets threshold for inducing automatic report for light. Sets lux threshold.

DEFAULT = 100

24. Light automatic report based on time.

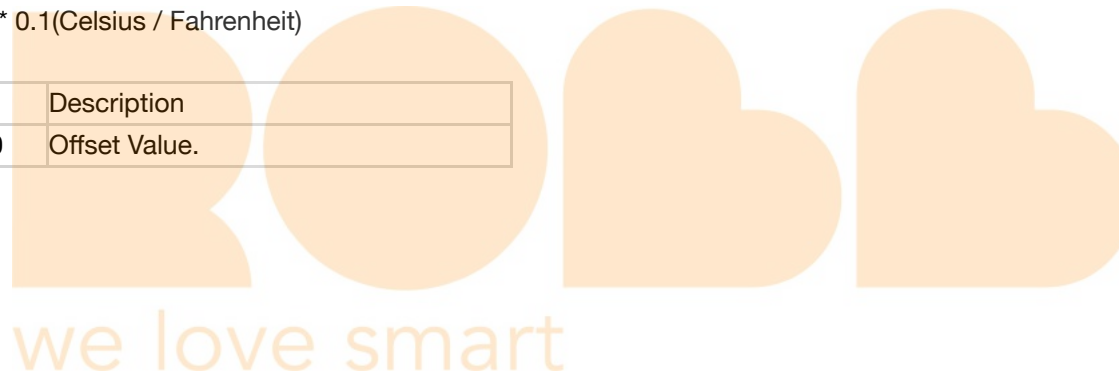

This parameter is configured the time interval for Light sensor report. This value is larger, the battery life is longer.

Parameter #	Size	Value	Description
24	2	1-32767	Automatic report set in seconds.

DEFAULT = 3600

31. Light Sensor Offset Value.

The current measuring light intensity value can be offset by setting a add and minus a value by this setting.

Parameter #	Size	Value	Description
31	2	0	Disable Threshold Report for Light Sensor
		-1000 - 1000	

DEFAULT = 0

100. Light Sensor Calibration.

This configuration defines the calibrated scale for ambient light intensity. Due to the method and position that the sensor mounted and the cover of sensor will bring measurement error, you can get more real light intensity by this parameter setting. You should run the steps for lux sensor calibration

To use this calibration accurately, you must use a accurate lux meter such as this: <https://www.amazon.com/HDE-LX-1010B-Digital-Luxmeter-Display/dp/B00992B29I> (<https://www.amazon.com/HDE-LX-1010B-Digital-Luxmeter-Display/dp/B00992B29I>) (This is purely an example, the more accurate lux meter you have, the better calibration setting you will be able to use).

- 1) Set this parameter value to default (Assumes the sensor has been added in a Z-Wave Network).
- 2) Place a digital luxmeter close to sensor and keep the same direction, monitor the light intensity value (**Vm**) and record it. At the same time you should record the value (**Vs**) of your digital luxmeter.
- 3) Calculate $k = Vm / Vs$. to get k coefficient.
- 4) The value of k is then multiplied by 1024 and rounded to the nearest whole number.
- 5) Set the value you got in 4 to this parameter and push the setting to your TriSensor.

For example,

$V_m = 300$, $V_s = 2600$, then

$k = (2600 / 300) * 1024$

$k = 8.6667 * 1024 = 8874.7 \approx 8875$ (Round up)

The parameter should be set to 8875.

Parameter #	Size	Value	Description
100	2	1-32767	Calibrates scale for ambient light

DEFAULT = 1024

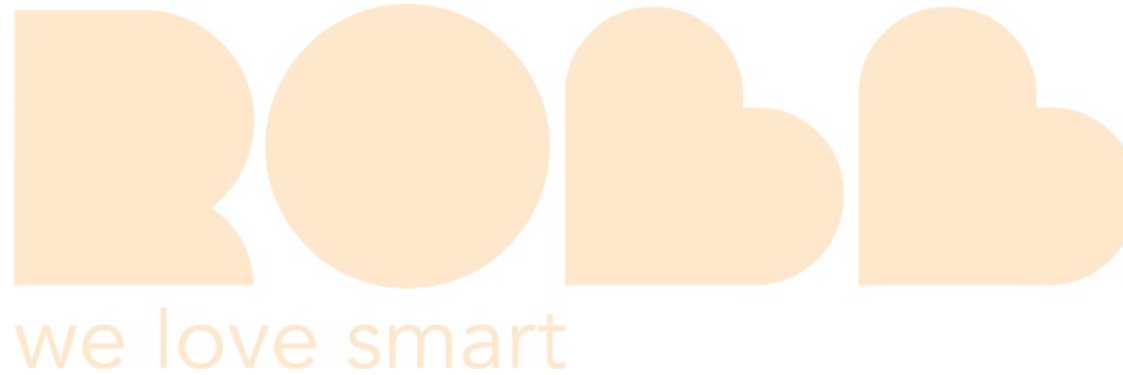

 Preview