

# Radiator Thermostat user guide

Modified on: Thu, 24 Oct, 2019 at 10:54 PM

## Aeotec Radiator Thermostat

(<http://aeotec.com/z-wave-plug-in-switch>) Aeotec Radiator Thermostat (TRV) has been crafted to power connected lighting using S2 framework and **Z-Wave Plus** (<http://aeotec.com/z-wave-plus>). It is powered by Aeotec's **S2** (<https://aeotec.com/z-wave-s2>) technology.

To see whether Aeotec Radiator Thermostat is known to be compatible with your Z-Wave system or not, please reference our **Z-Wave gateway comparison** (<http://aeotec.com/z-wave-gateways>) listing. The **technical specifications of Aeotec Radiator Thermostat** (<https://aeotec.freshdesk.com/a/solutions/articles/6000224136>) can be viewed at that link.

### Get to Know your Radiator Thermostat

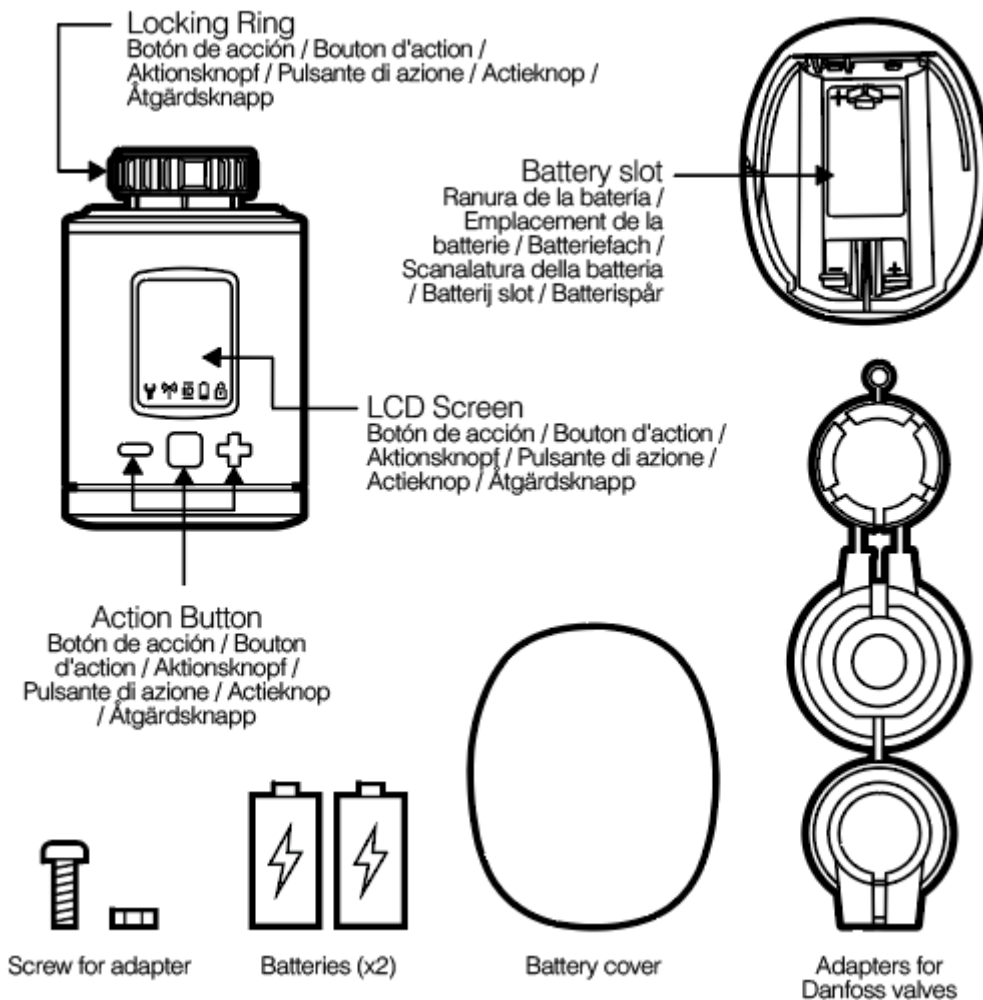

No adapter is required or supplied for the following valves:

- Heimeier
- Junkers Landy + Gyr
- MNG

- Honeywell
- Braukmann (thread of M30 x 1.5mm).
- The adapters for Danfoss RAV (pin must be plugged on the valve tappet) Danfoss RA and Danfoss RAVL are included with Radiator Thermostat.

For the following valves an additional adapter is required, which is not included:

- Herz M28 x 1,5 mm
- Comap M28 x 1,5 mm
- Vaillant 30,5 mm
- Oventrop M30 x 1,0 mm
- Meges M38 x 1,5 mm
- Ondal M38 x 1,5 mm
- Giacomini 22,6 mm
- Rossweiner M33 x 2,0 mm
- Markaryd M28 x 1,0 mm
- Ista M32 x 1,0 mm
- Vama M28 x 1,0 mm
- Pettinaroli M28 x 1,5 mm
- T+A M28 x 1,5 mm
- Gampper 1/2/6.

**Note:** A list of the adapters to be used and your part numbers can be found under **[Installation of Radiator Thermostat Adapters](https://aeotec.freshdesk.com/a/solutions/articles/6000226449)** (<https://aeotec.freshdesk.com/a/solutions/articles/6000226449>).

### **Important safety information.**

Please read this and other device guides carefully. Failure to follow the recommendations set forth by Aeotec Limited may be dangerous or cause a violation of the law. The manufacturer, importer, distributor, and/or reseller will not be held responsible for any loss or damage resulting from not following any instructions in this guide or in other materials.

Keep product away from open flames and extreme heat. Avoid direct sunlight or heat exposure.

Radiator Thermostat is intended for indoor use in dry locations only. Do not use in damp, moist, and/or wet locations.

### **Safety Warning for Batteries.**

The product contains batteries. Please remove the batteries when the device is not used. Do not mix batteries of different charging level or different brands.

## **Quick Start.**

In order to include/pair/add a Z-Wave device to a network, it **must be in a factory default state**. Please make sure to reset the device into factory default. You can do this by performing an **Exclusion** or **Manual Factory Reset** operation as described below in the manual in the **Advanced** section. Every Z-Wave controller is able to perform these operations (even while not paired to that controller) however it is recommended to use the primary controller of the previous network to make sure the device is excluded properly from its previous network.

### Inserting batteries.

1. Remove the battery cover by simply pulling it off.
2. Now insert the batteries.
3. Pay attention to the correct polarity!
4. Then close up the battery cover by pushing it back on.

**Note:** When you change batteries in Radiator Thermostat, the configuration of your Z-Wave network is maintained so you do not need to pair it again.

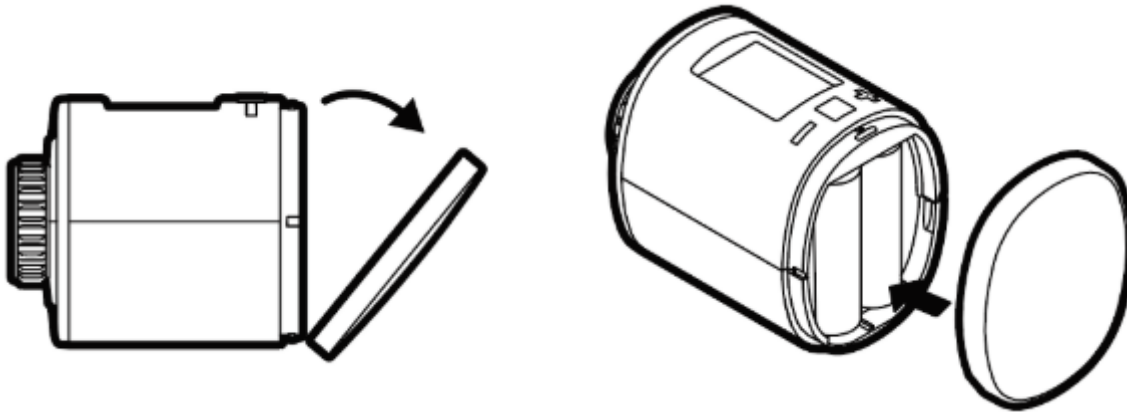

### Pairing Radiator Thermostat into your Z-Wave Network.

1. Start Inclusion/Pair/Add mode of your primary Z-Wave Controller.
2. Press the Boost-Button once on Radiator Thermostat.
3. Aeotec Radiator Thermostat will show the assigned NodeID provided by the Z-Wave Controller.

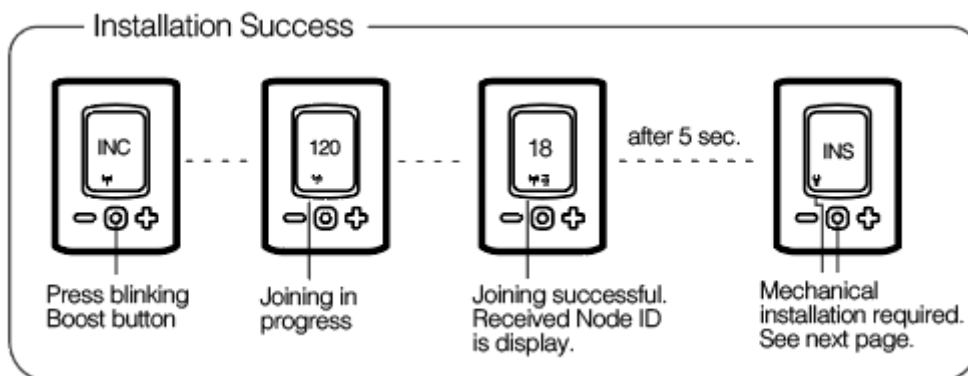

4. If the inclusion failed, "ERR" will appear on the display and the LED will light red. If this happens, try factory resetting Radiator Thermostat and restart the steps for Z-Wave inclusion from step 1.

### Installation.

#### 1. Mount the Radiator Thermostat

After adding Radiator Thermostat to your Z-Wave network it is ready to be installed on directly on your radiator. The LCD shows INS. **Do not press the boost button yet.**

### 1.1 Installation at the radiator without Adapter

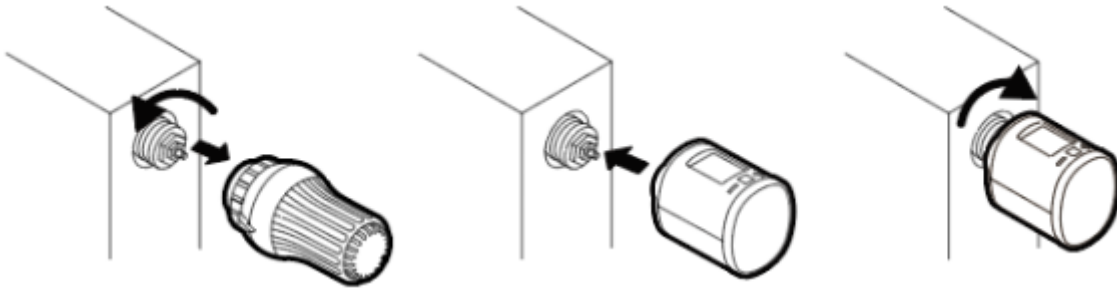

1.2 Installation at the radiator with Adapter, you may reference this page which provides deeper details on the installation of Radiator Thermostat with an adapter: **[Installation of Radiator Thermostat Adapters.](https://aeotec.freshdesk.com/a/solutions/articles/6000226449)**  
<https://aeotec.freshdesk.com/a/solutions/articles/6000226449>

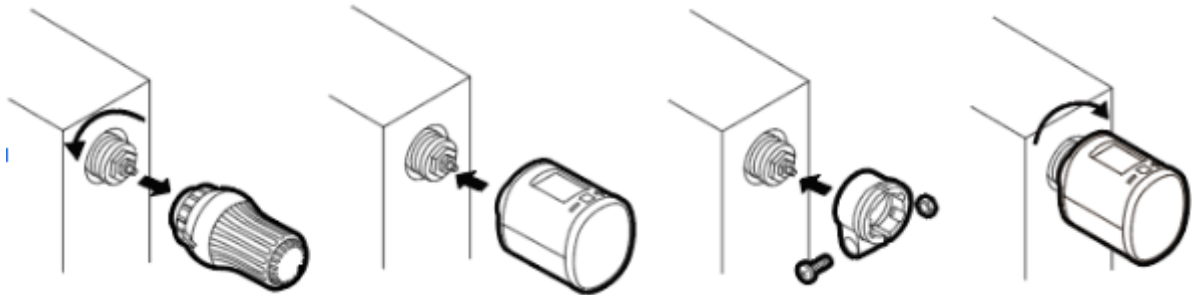

## 2. Mechanical Installation.

These steps will complete the installation of Radiator Thermostat.

2.1 Press the boost button to start the mechanical installation.

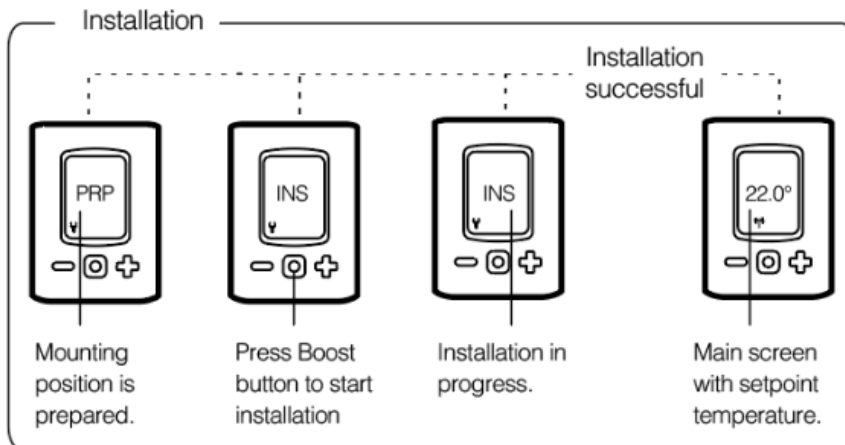

2.2 If the installation fails, "ER1" will appear in the display and the LED will turn red. If this happens, press the boost button to clear the error, then press the boost button again to start the installation again.

2.3 If you cannot pass the error, this will indicate a mechanical error or the use of the wrong adapter. Double-check the mounting installation and then try again.

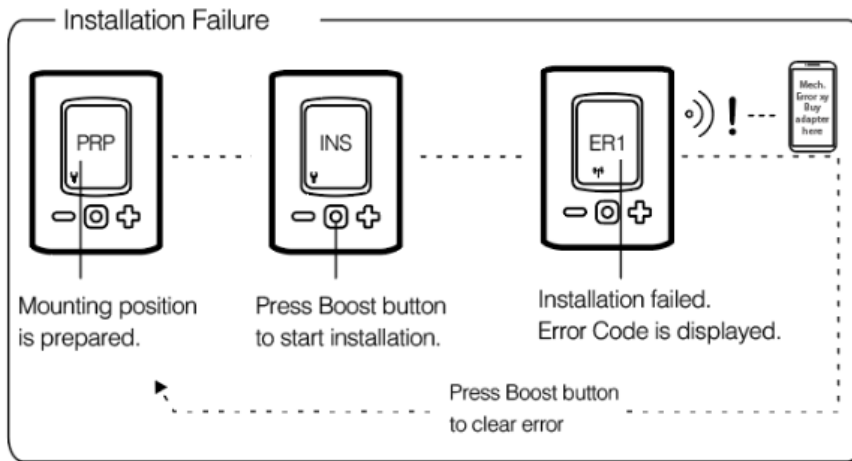

## General Device function information.

### Buttons and their functions.











Minus



Boost







Plus

Button	Interaction	Result/Behavior
	Press once	Decrease room temperature by 0,5°C
	Press and hold	Decrease room temperature by 0,5°C lower every 0,5 seconds or until the lowest temperature is set
	Press once	Increase room temperature by 0,5°C
	Press and hold	Increase room temperature by 0,5°C and raise every 0,5 seconds or until the highest temperature is set
	Push once	<ul style="list-style-type: none"> <li>- Confirm action which is displayed in the LED</li> <li>- Switch in the Boost mode (Quick Heat)</li> <li>- Quit Boost mode, if currently active</li> </ul>
	Hold for 3 seconds	The LCD shows Z-Wave Node ID
	Hold for 5 seconds	Exclusion Mode
	Hold while unpowered and insert batteries	Factory Reset
	Hold both simultaneously for 3 seconds	Sets or clear child protection

### Boost Led indicator.



Color	State	Meaning
	Blinking	OTA Update is in process
	Lights constantly for 5 seconds	A task has failed
	Permanently on	An error occurred
	Blinking	User conformation is required to start a task
	Lights constantly for 5 seconds	A task was completed successfully

### LCD icons.

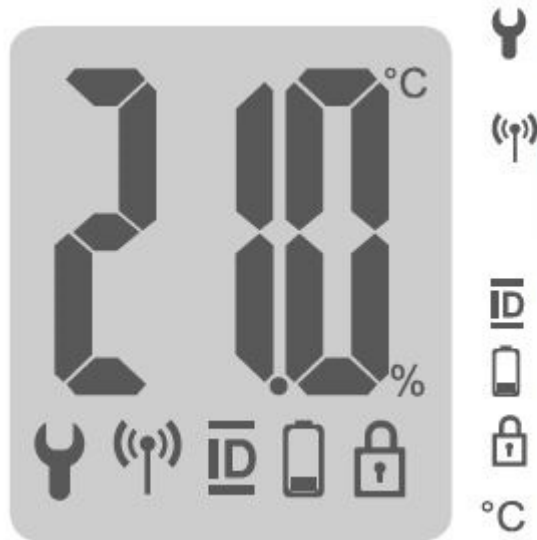

**Wrench:** Lights up if mechanical tasks are ongoing

**Antenna:**

Displays the Radiator Thermostat network state.

Segment visible: rf-link established

Segment turnoff: rf-link lost

**ID:** Lights up if the Display shows the Z-Wave NodeID

**Battery:** Lights up if less than 15% battery is remaining

**Lock:** Light up if child protection is set

**Degree Celsius:** Displayed if the LCD shows a setpoint temperature

**Setpoint adjustment.**

- The setpoint is adjusted by the plus ( + ) and minus ( - ) button.
- Altering the setpoint locally will set the Radiator Thermostat to heating mode.
- The energy-saving setpoint can only be adjusted via Z-Wave.
- The configurable setpoint range is 8°C to 28°C.
- If the setpoint is increased/decreased above/below the set point limits the Radiator Thermostat will change into boost/off - mode.

**Window open detection.**

- If the room temperature drops, window open detection will trigger.
  - Radiator Thermostat will change temporarily in off mode for 15 minutes.
  - Window open detection will end automatically after 15 minutes, then previously activity will restore.
- Window open detection can be canceled by a button press.
- Window open detection is disabled during the manufacturer-specific mode.
- The sensitivity of the window open detection can be configured via parameter 7.

## Advanced.

### Exclude/Remove Radiator Thermostat.

You must exclude/unpair your Radiator Thermostat before it can be paired to another Z-Wave controller. This is the preferred method of factory resetting Radiator Thermostat to ensure the previous Z-Wave controller does not leave a Phantom Node (a Z-Wave device that was previously existing but no longer a part of the network and still shows as a device).

1. Unmount Radiator Thermostat.

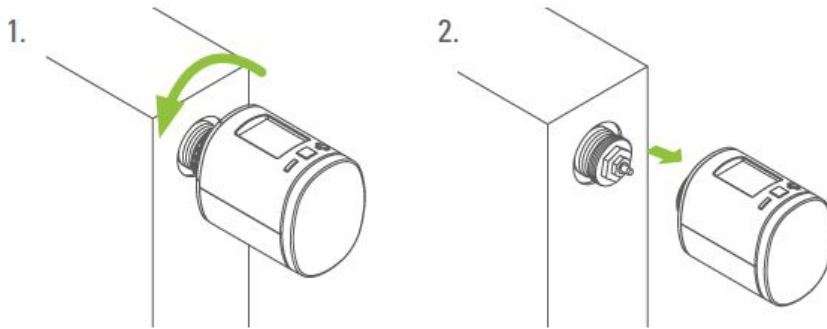

### 2. Removing from Z-Wave network

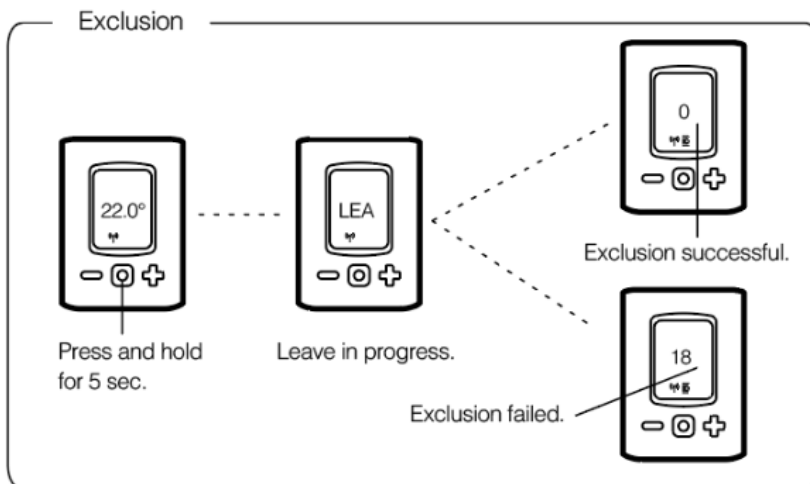

### Child protection.

If you have children who may press the buttons of Radiator Thermostat, you can enable child protection which will disable manual control of Radiator Thermostat.

- Press and hold plus ( + ) and minus ( - ) button simultaneously for 3 seconds to toggle enable/disable child protection.

**Note:** If child lock is enabled, this icon will appear:



- If the Radiator Thermostat is set into the highest protection level it is no longer possible to operate the device locally.



## Altering the operating states.

You can manually control some of Radiator Thermostats functions using its buttons.

### 1. Off-Mode

- Press and hold the minus ( - ) button until OFF is displayed.

### 2. Boost-Mode

- Push the boost button.
- Alternatively, press and hold the plus ( + ) button until ON is displayed.

### 3. Heating-Mode

- If the operating state is not heating mode.
- Press the plus ( + ) or minus ( - ) button will bring the device in heating mode.

## Display NodeID.

If you forget what Node ID your Radiator Thermostat is, and your Z-Wave controller does not provide a good method to locate it, you can display the NodeID by:

- Press and hold the boost button for 3 seconds to display the NodeID.

## Manually Reset your device.

If you find that your Z-Wave controller is no longer functional or working, you can manually reset Radiator Thermostat using these steps:

1. Remove batteries.
2. Press and hold the Boost button.
3. While still holding Boost button insert batteries.
4. The LCD will show "RES" icon.
5. Release the Boost button.
6. Now press the Boost Button to initiate a manual factory reset.

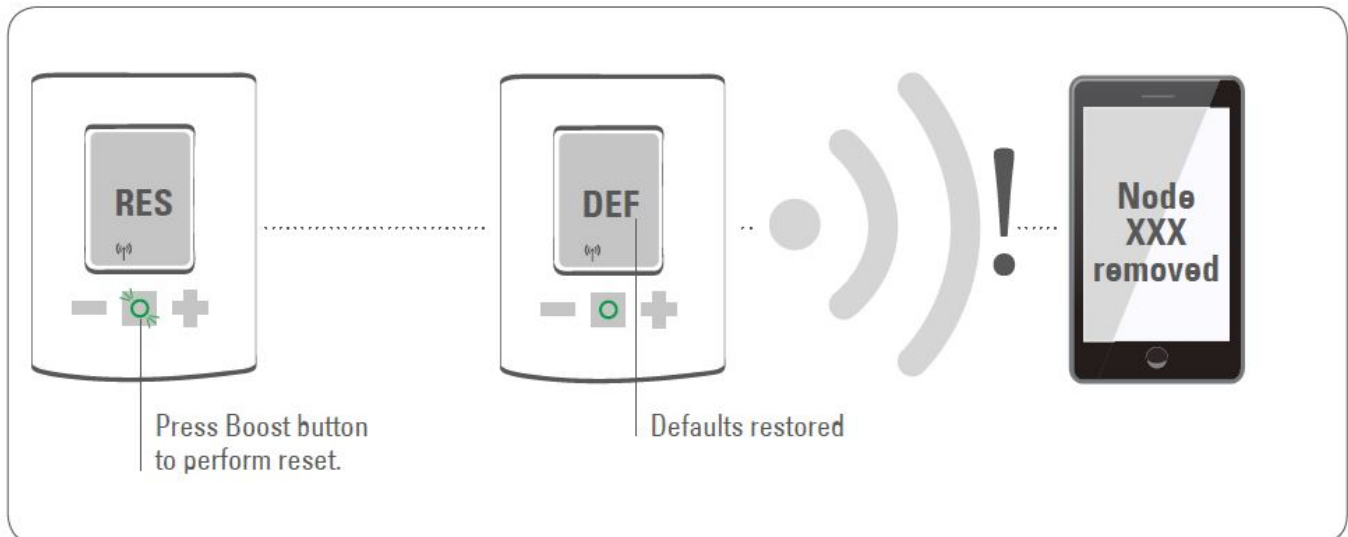

## Configuration Parameters

### Parameter 1: LCD invert

*Inverts the LCD orientation.*

Size: 1 Byte, Default Value: 0

Setting	Description
0	Normal orientation
1	LCD content inverted

#### Parameter 2: LCD Timeout

*Configures the timeout of the LCD.*

Size: 1 Byte, Default Value: 0

Setting	Description
0	LCD always on
5 - 30	LCD timeout in seconds

#### Parameter 3: Backlight

*Enables or disables the LCD-Backlight.*

Size: 1 Byte, Default Value: 1

Setting	Description
0	Backlight disabled
1	Backlight enabled

#### Parameter 4: Battery report

*Enables or disables unsolicited battery reporting once a day.*

Size: 1 Byte, Default Value: 1

Setting	Description
0	Battery reporting disabled
1	Battery reporting enabled

#### Parameter 5: Measured temperature report

*Reports the measured room temperature on change.*

Size: 1 Byte, Default Value: 5

Setting	Description
0	Reporting disabled
1 - 50	Reporting Delta in 1/10 Celcius

#### Parameter 6: Valve percentage report

*Reports the valve percentage on change.*

Size: 1 Byte, Default Value: 0

Setting	Description
0	Reporting disabled
1 - 100	Reporting Delta in percent

#### Parameter 7: Window open detection

*Configures the sensitivity of the window open detection.*

**Sensitivity level:**

1 low

2 medium

3 high

Size: 1 Byte, Default Value: 2

Setting	Description
0	Detection disabled
1 - 3	Sensitivity level

#### **Parameter 8: Measured temperature offset**

*Configures an offset for the measured temperature. Set the offset to -128 (0x80) if measured temperature is provided externally.*

Size: 1 Byte, Default Value: 0

Setting	Description
0 - 50	Offset in 1/10 Celcius (0°C - 5°C)
128	Temperature is supplied externally
206 - 255	Offset in 1/10 Celcius (-5°C - 0,1°C)

## **Troubleshooting**

<b>Problem</b>	<b>Reason</b>	<b>Solution</b>
Battery Icon	Batteries do not have enough power	Replace batteries
Heating element does not warm up	<ul style="list-style-type: none"> <li>- Is the boiler water temperature O.K.?</li> <li>- Valve does not open, is it calcified after the summer pause/heating pause</li> </ul>	<ul style="list-style-type: none"> <li>- Adjust the temperature of the boiler water.</li> <li>- Remove the Radiator Thermostat, move the valve back and forth per hand or with a tool.</li> </ul>
Heating element does not cool down	Valve does not close completely. It may be that the closing point of your valve seat has shifted.	Unmount Radiator Thermostat, Move the valve stem several times by hand, it may be that adaptation is impossible because your valve is calcified or the seat no longer performs its function.
Pressure piece falls out (This can also cause an E1-error)	Due to an endless thread the pressure piece, which is situated at the bottom, can fall out if the device has not been affixed on the valve.	Remove batteries. Put in the pressure piece. Insert the batteries. The endless thread is rotating now and fixes the pressure piece again.
ER1 - ER3 and ERR	The error code can be cleared by pressing the boost button.	
ERR	Inclusion failed	Z-Wave Controller out of range
ER1	Valve positioning not possible	Check if the valve is jammed
ER2	Valve not detected	Check if Radiator Thermostat is correctly mounted
ER3	Valve closing point not detected	Check if Radiator Thermostat is correctly mounted