

Nice

Motion-Control

Wireless motion, light and temperature sensor

EN - Instructions and warnings for installation and use

Nice

1 WARNINGS AND GENERAL PRECAUTIONS

- **CAUTION! – This manual contains important instructions and warnings for personal safety.** Carefully read all parts of this manual. If in doubt, suspend installation immediately and contact Nice Technical Assistance.
- **CAUTION! – Important instructions: keep this manual in a safe place to enable future product maintenance and disposal procedures.**
- **CAUTION! – Any use other than that specified herein or in environmental conditions other than those stated in this manual is to be considered improper and is strictly forbidden!**
- The product's packaging materials must be disposed of in full compliance with local regulations.
- Never apply modifications to any part of the device. Operations other than those specified may only cause malfunctions. The manufacturer declines all liability for damage caused by makeshift modifications to the product.
- Do not expose this product to moisture, water or other liquids.
- This product is designed for indoor use only. Do not use outside!
- This product is not a toy. Keep away from children and animals!
- If the battery is leaking and the contained material is ingested, rinse mouth and surrounding area with clear water. Seek medical attention right away.

2 PRODUCT DESCRIPTION

Motion-Control is a universal Z-Wave™ multi-sensor. Along with detecting motion, the device measures the temperature and light intensity. The sensor has a built-in accelerometer to detect any tampering of the device.

Motion-Control is a battery-powered device designed to be installed quickly and easily on any surface. The LED indicator signals motion, temperature level, operating mode and can indicate if the device is within the Z-Wave network.

The device can be used for lighting scenes and presence monitoring systems.

Main features

- compatible with any Z-Wave™ or Z-Wave Plus™ Controller
- supports protected mode (Z-Wave network security mode) with AES-128 encryption
- detects motion using a passive IR sensor
- measures ambient temperature
- measures light intensity
- detects vibrations
- extremely easy installation
- may be installed anywhere - wall or any surface
- battery powered
- theft and tampering protection - once vibrations are detected, the notification is sent to the main controller
- detected movement, temperature and vibrations are signalled by the built-in LED diode

Motion-Control is a fully compatible Z-Wave Plus™ device.

This device may be used with all devices certified with the Z-Wave Plus certificate and should be compatible with such devices produced by other manufacturers. All non-battery operated devices within the network will act as repeaters to increase reliability of the network. The device is a Security Enabled Z-Wave Plus product and a Security Enabled Z-Wave Controller must be used in order to fully utilize the product.



3 BASIC ACTIVATION

1. Turn the cover counter-clockwise and open it.

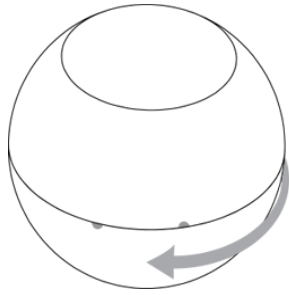

2. Remove the battery blocker.

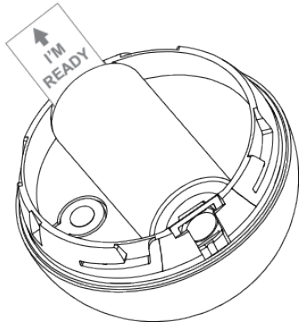

3. Add the device (see chapter "4. Adding the device").
4. Wake up the sensor by clicking the B-button.

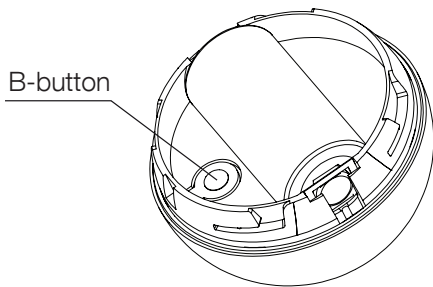

5. Close the cover and turn it clockwise.
6. Install the device (see chapter "6. Physical Installation").

4 ADDING THE DEVICE

- Adding in security mode must be performed up to 2 meters from the controller.
- In case of problems with adding the device, please reset the device and repeat the adding procedure.

Adding (Inclusion) - Z-Wave device learning mode, allowing to add the device to existing Z-Wave network.

To add the device to the Z-Wave network **manually**:

1. Open the cover.
2. Place the Motion-Control within the direct range of your Z-Wave controller.
3. Set the main controller in (security/non-security) add mode (see the controller's manual).
4. Quickly, three times press the B-button.

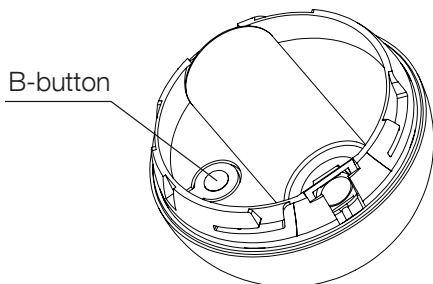

5. Wait for the adding process to end.
6. Successful adding will be confirmed by the Z-Wave controller's message.

5 REMOVING THE DEVICE

Removing (Exclusion) - Z-Wave device learning mode, allowing to remove the device from existing Z-Wave network.

To remove the device from the Z-Wave network:

1. Open the cover.
2. Place the Motion-Control within the direct range of your Z-Wave controller.
3. Set the main controller in remove mode (see the controller's manual).
4. Quickly, three times press the B-button.

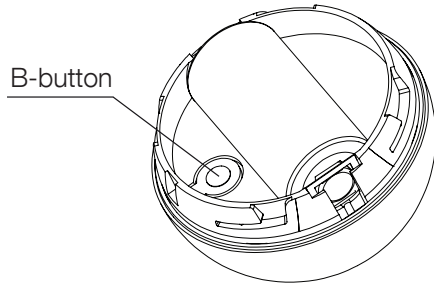

5. Wait for the removing process to end.
6. Successful removing will be confirmed by the Z-Wave controller's message.

Note. Removing the device from the Z-Wave network restores all the default parameters of the device.

6 PHYSICAL INSTALLATION

- Remember to add the device to the Z-Wave network prior to installation, as the adding procedure must be performed within the direct range of the controller.

6.1 - Detection range

Detection range of the Motion-Control is shown below. Actual range of the Sensor can be influenced by environmental conditions.

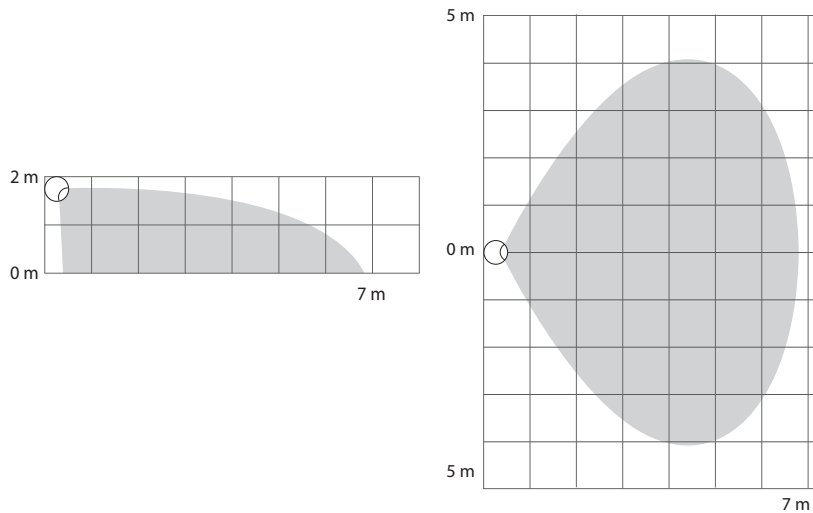

6.2 - Installation location and working conditions

The Motion-Control should be installed in the corner of the room or perpendicularly to the doors.

Moving objects such as trees blowing in the wind, cars passing by, windmills, and moving masses of air and heat within the sensor's detection area can cause false motion detection.

The hanging height of the product should be less than 2m.

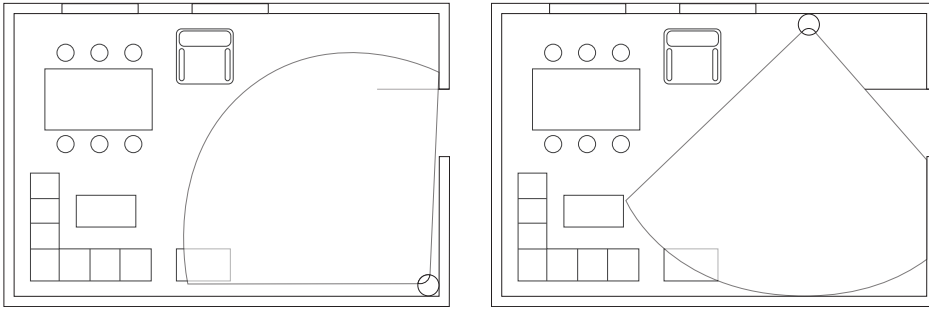

6.3 - Installing the Motion-Control

1. Install the holder (using an expansion bolt or a sticker).

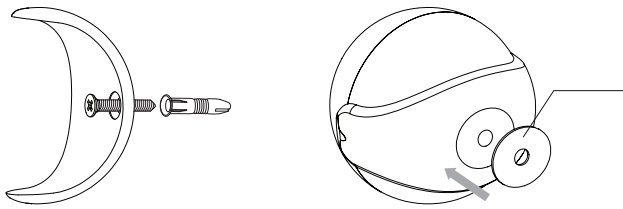

2. Insert the device into the holder.
3. Test the operation - check whether the device indicates motion detection.

7 OPERATING THE DEVICE

7.1 - Controlling the Motion-Control using the B-button:

The Motion-Control is equipped with a B-button, which allows to use the menu and additionally perform the following actions:

- **1x click:** wake up the device or select the desired menu option (if menu is active)
- **3x click:** add/remove the device to/from a Z-Wave network
- **Holding:** enter/navigate through the menu

7.2 - Visual indications

The Motion-Control is equipped with a LED diode, signalling sensor's operating modes and alarms. In addition the visual indicator may inform of the Z-Wave network range and the current temperature.

Visual indicator signalling modes:

1. Motion Alarm colour will vary depending on the temperature. The colour and the signalling mode can be set in parameter 80.
2. Tamper alarm is signalled with an alternating blinking in LAPD colours (red - blue - white).
3. The Z-Wave Node Info command frame is signalled with glowing in blue. Node Info command frame is sent each time the device wakes up.
4. Menu position is signalled with assigned illumination colour.

7.3 - Menu

Menu allows to perform Z-Wave network actions. In order to use menu:

1. Press and hold the B-button.
2. Wait for the device to indicate desired position with a colour:
 - VIOLET - Z-Wave network's range test
 - YELLOW - device reset
3. Release the B-button.
4. Click the B-button to confirm selection.

7.4 - Waking up the Motion-Control

The Motion-Control needs to be woken up to receive information on new configurations from the controller, like parameters and associations. To wake up the sensor manually click the B-button located inside the housing.

7.5 - Seismograph mode

The Motion-Control can be configured to work as a simple earthquake detector, by setting the parameter 24 value to 1. Reports with scale of the vibrations (in the Modified Mercalli Scale) will be sent immediately after vibrations have been detected. Minimal power of vibrations that will be reported, can be set in parameter 20. Once the vibrations cease and time of sustaining alarm elapses, reports will be stopped.

7.6 - Orientation in space

The Motion-Control has a built-in accelerometer. When the parameter 24 is set to 2, Z-Wave network controller will be informed on the Sensor's orientation in space by sending report after triggering tamper alarm.

7.7 - Resetting the Motion-Control

Reset procedure erases the memory, including all information on the Z-Wave network and the main controller.

1. Open the cover.
2. Press and hold the B-button.
3. Wait for visual indicator to glow yellow (2nd menu position).
4. Release the B-button.
5. Click the B-button to confirm selection.
6. After few seconds the device will be reset, which is signalled with the red, fading visual indicator colour.

Note. Resetting the device is not the recommended way of removing the device from the Z-Wave network. Use reset procedure only if the primary controller is missing or inoperable. Certain device removal can be achieved by the procedure of removing described in chapter "5. Removing the device".

7.8 - Notification report

The device uses Notification Command Class to report different events.

Table A1 - Notification reports of the events	
Notification Type	Event
Home Security	Tampering, product covering removed
Home Security	Motion Detection, unknown location

Note. Command Class Basic value is related to the status of Motion-Control (0x00 - no motion, 0xFF - motion detected).

8 ASSOCIATIONS

Association (linking devices) - direct control of other devices within the Z-Wave system network e.g. Dimmer, Relay Switch, Roller Shutter or scene (may be controlled only through a Z-Wave controller).

Association allows direct transfer of control commands between devices, is performed without participation of the main controller and requires associated device to be in direct range.

The Motion-Control provides the association of five groups:

- 1st association group – "Lifeline" reports the device status and allows for assigning single device only (main controller by default).
- 2nd association group – "Motion" is assigned to the Motion-Control - sends Basic Set command frames to the associated devices.
- 3rd association group – "Tamper" is assigned to the tamper - sends tamper alarm and alarm cancellation frames to the associated devices.
- 4th association group – "Motion BC" is assigned to the Motion-Control - sends motion detection and alarm cancellation frames to the associated devices. Provides backward compatibility with controllers not supporting Z-Wave Plus protocol.
- 5th association group – "Tamper BC" is assigned to the tamper - sends tamper alarm and alarm cancellation frames to the associated devices. Provides backward compatibility with controllers not supporting Z-Wave Plus protocol.

The Motion-Control in 2nd to 5th group allows to control 5 regular and 5 multichannel devices per an association group, with the exception of "Lifeline" that is reserved solely for the controller and hence only 1 node can be assigned.

It is not recommended to associate more than 10 devices in general, as the response time to control commands depends on the number of associated devices. In extreme cases, system response may be delayed.

9 Z-WAVE RANGE TEST

The device has a built in Z-Wave network main controller's range tester.

- To make Z-Wave range test possible, the device must be added to the Z-Wave controller. Testing may stress the network, so it is recommended to perform the test only in special cases.
- Communication mode of the device may switch between direct and one using routing, especially if the device is on the limit of the direct range.

To perform a range test:

1. Open the cover.
2. Press and hold the B-button.
3. Wait for visual indicator to glow violet (1st menu position).
4. Release the B-button.
5. Click the B-button to confirm selection.
6. Visual indicator will indicate the Z-Wave network's range (range signalling modes described below).
7. To exit Z-Wave range test, press the B-button briefly.

Z-Wave range tester signalling modes:

Visual indicator pulsing green - the Motion-Control attempts to establish a direct communication with the main controller. If a direct communication attempt fails, the device will try to establish a routed communication, through other modules, which will be signalled by visual indicator pulsing yellow.

Visual indicator glowing green - the Motion-Control communicates with the main controller directly.

Visual indicator pulsing yellow - the Motion-Control tries to establish a routed communication with the main controller through other modules (repeaters).

Visual indicator glowing yellow - the Motion-Control communicates with the main controller through the other modules. After 2 seconds the device will retry to establish a direct communication with the main controller, which will be signalled with visual indicator pulsing green.

Visual indicator pulsing violet - the Motion-Control does communicate at the maximum distance of the Z-Wave network. If connection proves successful it will be confirmed with a yellow glow. It's not recommended to use the device at the range limit.

Visual indicator glowing red - the Motion-Control is not able to connect to the main controller directly or through another Z-Wave network device (repeater)

10 ADVANCED PARAMETERS

The device allows to customize its operation to user's needs using configurable parameters.

The settings can be adjusted via Z-Wave controller to which the device is added. The way of adjusting them might differ depending on the controller.

Wake up interval

Motion-Control will wake up after each defined time interval and always try to connect with the main controller. After a successful communication attempt, the sensor will update configuration parameters, associations, and settings and will go into standby mode. After a failed communication attempt (e.g. lack of Z-Wave range), the device will go into standby mode and retry to establish a connection with the main controller after the next interval.

Available settings: 1-65535 (1-65535 seconds)

Default setting: 7200 (every 2 hours)

Wake up may be performed manually by a single B-button click.

Longer time interval means less frequent communication and thus a longer battery life.

Table A2 - Motion-Control - Available parameters

Parameter:	1. Motion detection - sensitivity		
Description:	The lower the value, the more sensitive the PIR sensor is.		
Available settings:	8-255		
Default setting:	15	Parameter size:	2 [bytes]
Parameter:	2. Motion detection - blind time		
Description:	PIR sensor is "blind" (insensitive) to motion after last detection for the amount of time specified in this parameter. Shorter time periods allow to detect motion more frequently, but the battery will be drained faster. Blind time should be shorter than the time period set in parameter 6 (alarm cancellation delay).		
Available settings:	0-15 (0.5-8 seconds, time [s] = 0.5 x (value+1))		
Default setting:	15	Parameter size:	1 [byte]
Parameter:	3. Motion detection - pulse counter		
Description:	This parameter determines the number of moves required for the PIR sensor to report motion. The higher the value, the less sensitive the PIR sensor is. It is not recommended to modify this parameter settings!		
Available settings:	0 - 1 pulse 1 - 2 pulses 2 - 3 pulses 3 - 4 pulses		
Default setting:	1 (2 pulses)	Parameter size:	1 [byte]
Parameter:	4. Motion detection - window time		
Description:	Period of time during which the number of moves set in parameter 3 must be detected in order for the PIR sensor to report motion. The higher the value, the more sensitive the PIR sensor is. It is not recommended to modify this parameter setting!		
Available settings:	0 - 4 seconds 1 - 8 seconds 2 - 12 seconds 3 - 16 seconds		
Default setting:	2 (12 seconds)	Parameter size:	1 [byte]

Parameter:	6. Motion detection - alarm cancellation delay		
Description:	Time period after which the motion alarm will be cancelled in the main controller and associated devices. Any motion detected during this period resets the timer.		
Available settings:	1-32767 (in seconds)		
Default setting:	30 (30s)	Parameter size:	2 [bytes]
Parameter:	8. Motion detection - operating mode		
Description:	This parameter determines in which part of day the PIR sensor will be active. This parameter influences only the motion reports and associations. Tamper, light intensity and temperature measurements will be still active, regardless of this parameter settings.		
Available settings:	0 - PIR sensor always active 1 - PIR sensor active during the day only 2 - PIR sensor active during the night only		
Default setting:	0	Parameter size:	1 [byte]
Parameter:	9. Motion detection - night/day		
Description:	This parameter defines the difference between night and day in terms of light intensity, used in parameter 8.		
Available settings:	1-32767 (1-32767 lux)		
Default setting:	200 (200 lux)	Parameter size:	2 [bytes]
Parameter:	12. BASIC command class configuration		
Description:	This parameter determines the command frames sent to 2nd association group (assigned to PIR sensor). Values of BASIC ON and BASIC OFF command frames can be modified with dedicated parameters (14 and 16).		
Available settings:	0 - BASIC ON and OFF command frames sent in Basic Command Class 1 - only the BASIC ON command frame sent in Basic Command Class 2 - only the BASIC OFF command frame sent in Basic Command Class		
Default setting:	0	Parameter size:	1 [byte]
Parameter:	14. BASIC ON command frame value		
Description:	The command frame sent at the moment of motion detection. Further motion detections, during the cancellation time, will not result in sending the association.		
Available settings:	0-255		
Default setting:	255	Parameter size:	2 [byte]
Parameter:	16. BASIC OFF command frame value		
Description:	The command frame sent at the moment of motion alarm cancellation, after cancellation delay time specified in parameter 6.		
Available settings:	0-255		
Default setting:	0	Parameter size:	2 [bytes]
Parameter:	18. Associations in Z-Wave network Security Mode		
Description:	This parameter defines how commands are sent in specified association groups: as secure or non-secure. Parameter is active only in Z-Wave network security mode. It does not apply to 1st group "Lifeline". The values of 18th parameter can be combined, which means that with a default value of 15 the parameter is active in all the association groups listed. For example, a value of 3 will mean encryption for groups 2 and 3. Note: A table showing the dependence of association group encryption on the value of the parameter can be found at the end of the chapter.		
Available settings:	0 - none of the groups sent as secure 1 - 2nd group sent as secure 2 - 3rd group sent as secure 4 - 4th group sent as secure 8 - 5th group sent as secure		
Default setting:	15	Parameter size:	1 [byte]
Parameter:	20. Tamper - sensitivity		
Description:	This parameter determines the change in force acting on the device, that will result in reporting tamper alarm - g-force acceleration.		
Available settings:	0 - tamper inactive 1-121 - (0.08-2g; every 0.016g)		
Default setting:	20 (0.4g)	Parameter size:	1 [byte]
Parameter:	22. Tamper - alarm cancellation delay		

Description:	Time period after which a tamper alarm will be cancelled in the main controller and associated devices. Any tampering detected during this period will not extend the delay.		
Available settings:	1-32767 (in seconds)		
Default setting:	30 (30s)	Parameter size:	2 [bytes]
Parameter:	24. Tamper - operating modes		
Description:	This parameter determines function of the tamper and sent reports. It is an advanced feature serving much more functions than just detection of tampering.		
Available settings:	0 - tamper only 1 - tamper and earthquake detector 2 - tamper and orientation in space		
Default setting:	0	Parameter size:	1 [byte]
Parameter:	25. Tamper - alarm cancellation		
Description:	This parameter allows to disable cancellation of the tamper alarm.		
Available settings:	0 - do not send tamper cancellation report 1 - send tamper cancellation report		
Default setting:	1	Parameter size:	1 [byte]
Parameter:	28. Tamper - broadcast mode		
Description:	The parameter determines whether the tamper alarm frame will or will not be sent in broadcast mode. Alarm frames sent in broadcast mode can be received by all of the devices within range (if they accept such frames), but not repeated by them.		
Available settings:	0 - tamper alarm sent to 3rd association group 1 - tamper alarm sent in broadcast mode		
Default setting:	0	Parameter size:	1 [byte]
Parameter:	29. Tamper - backward compatible broadcast mode		
Description:	The parameter determines whether the backward compatible tamper alarm frame will or will not be sent in broadcast mode. Alarm frames sent in broadcast mode can be received by all of the devices within range (if they accept such frames), but not repeated by them. This parameter provides backward compatibility with controllers not supporting Z-Wave Plus.		
Available settings:	0 - backward compatible tamper alarm sent to 5th association group 1 - backward compatible tamper alarm sent in broadcast mode		
Default setting:	0	Parameter size:	1 [byte]
Parameter:	40. Illuminance report - threshold		
Description:	This parameter determines the change in light intensity level resulting in illuminance report being sent to the main controller.		
Available settings:	0 - reports are not sent 1-32767 (illuminance in lux)		
Default setting:	200 (200 lux)	Parameter size:	2 [bytes]
Parameter:	42. Illuminance report - interval		
Description:	Time interval between consecutive illuminance reports. The reports are sent even if there is no change in the light intensity. Frequent illuminance reports will shorten the battery life. Parameter value under 5 may result in blocking the temperature reports.		
Available settings:	0 - periodical reports are not sent 1-32767 (in seconds)		
Default setting:	3600 (1h)	Parameter size:	2 [bytes]
Parameter:	60. Temperature report - threshold		
Description:	This parameter determines the change in measured temperature that will result in new temperature report being sent to the main controller.		
Available settings:	0 - reports are not sent 1-255 (0.1-25.5°C, 0.1°C step)		
Default setting:	10 (1°C)	Parameter size:	2 [bytes]
Parameter:	62. Temperature measuring - interval		
Description:	Time interval between consecutive temperature measurements. The shorter the time, the more frequently the temperature will be measured, but the battery life will shorten. Temperature measurements are still performed during the wake up, even if the periodic measuring is disabled (parameter 62 set to 0).		

Available settings:	0 - temperature is not measured 1-32767 (in seconds)		
Default setting:	900 (900s)	Parameter size:	2 [bytes]
Parameter:	64. Temperature report - interval		
Description:	Time interval between consecutive temperature reports. The reports are sent even if there is no change in the temperature. Frequent temperature reports will shorten the battery life. Parameter value under 5 may result in blocking the illuminance reports.		
Available settings:	0 - periodical reports are not sent 1-32767 (in seconds)		
Default setting:	0	Parameter size:	2 [bytes]
Parameter:	66. Temperature offset		
Description:	The value to be added to the actual temperature, measured by the sensor (temperature compensation).		
Available settings:	-1000 - 1000 (-100 - 100°C, 0.1°C step)		
Default setting:	0 (0°C)	Parameter size:	2 [bytes]
Parameter:	80. Visual LED indicator - signalling mode		
Description:	This parameter determines the way in which visual indicator behaves after motion has been detected. Flashlight Mode - visual indicator glows in white for 10 seconds. If value of parameter 80 is set to 11, each detected motion extends the glowing by next 10 seconds.		
Available settings:	0 - LED inactive, Values from 1 to 9 - single long blink at the moment of reporting motion. No other motion will be indicated until alarm is cancelled. 1 - colour is temperature dependent, 2 - Flashlight Mode, 3 - white, 4 - red, 5 - green, 6 - blue, 7 - yellow, 8 - cyan, 9 - magenta Values from 10 to 18 - single long blink at the moment of reporting motion and one short blink each time the motion is detected again. 10 - colour is temperature dependent, 11 - Flashlight Mode, 12 - white, 13 - red, 14 - green, 15 - blue, 16 - yellow, 17 - cyan, 18 - magenta Values from 19 to 26 - single long blink at the moment of reporting motion and two short blinks each time the motion is detected again. 19 - colour is temperature dependent, 20 - white, 21 - red, 22 - green, 23 - blue, 24 - yellow, 25 - cyan, 26 - magenta		
Default setting:	10	Parameter size:	1 [byte]
Parameter:	81. Visual LED indicator - brightness		
Description:	This parameter determines the brightness of the visual LED indicator when indicating motion.		
Available settings:	0 - brightness determined by the illuminance (parameters 82 and 83) 1-100 (1-100%)		
Default setting:	50 (50%)	Parameter size:	1 [byte]
Parameter:	82. Visual LED indicator - illuminance for low indicator brightness		
Description:	Light intensity level below which brightness of visual indicator is set to 1%. The value of parameter 83 must be higher than the value of parameter 82.		
Available settings:	0 to value of parameter 83 (in lux)		
Default setting:	100	Parameter size:	2 [bytes]
Parameter:	83. Visual LED indicator - illuminance for high indicator brightness		
Description:	Light intensity level above which brightness of visual indicator is set to 100%.		
Available settings:	value of parameter 82 to 32767 (in lux)		
Default setting:	1000	Parameter size:	2 [bytes]
Parameter:	86. Visual LED indicator - temperature for blue colour		
Description:	This parameter determines minimal temperature that will result in blue visual indicator colour. Relevant only when parameter 80 has been properly configured.		

Available settings:	0 to value of parameter 87 (in Celsius degree)		
Default setting:	0 to value of parameter 87 (in Celsius degree)	Parameter size:	2 [bytes]
Parameter:	87. Visual LED indicator - temperature for red colour		
Description:	This parameter determines minimal temperature that will result in red visual indicator colour. Relevant only when parameter 80 has been properly configured.		
Available settings:	value of parameter 86 to 255 (in Celsius degree)		
Default setting:	28 (28°C)	Parameter size:	2 [bytes]
Parameter:	89. Visual LED indicator - tamper alarm		
Description:	This parameter allows to enable/disable indicating tamper alarm (flashing white, red and blue).		
Available settings:	0 - tamper alarm is not indicated 1 - tamper alarm is indicated		
Default setting:	1	Parameter size:	1 [byte]

Notes:

- Device operating in Security Mode does not send frames in broadcast mode. In this case leave the default values of parameters 28 and 29.

Table A3 - Dependence of association group encryption on the value of parameter 15

Value of the parameter	Association group 2	Association group 3	Association group 4	Association group 5
0				
1	encrypted			
2		encrypted		
3	encrypted	encrypted		
4			encrypted	
5	encrypted		encrypted	
6		encrypted	encrypted	
7	encrypted	encrypted	encrypted	
8				encrypted
9	encrypted			encrypted
10		encrypted		
11	encrypted	encrypted		encrypted
12			encrypted	encrypted
13	encrypted		encrypted	encrypted
14		encrypted	encrypted	encrypted
15	encrypted	encrypted	encrypted	encrypted

11 TECHNICAL SPECIFICATIONS

The product Motion-Control is produced by Nice S.p.A. (TV). Warnings: - All technical specifications stated in this section refer to an ambient temperature of 20 °C (± 5 °C) - Nice S.p.A. reserves the right to apply modifications to the product at any time when deemed necessary, while maintaining the same functionalities and intended use.

Motion-Control	
Power supply	3.0V DC battery
Battery type	CR123A
Recommended installation height	up to 2 meters
Operating temperature	0-40°C
Temperature measuring range	-20-100°C
Temperature measuring accuracy	0.5°C (within 0-40°C range)
Illuminance measuring range	0-32000 lux
Dimensions (diameter)	46 mm

- Radio frequency of individual device must be same as your Z-Wave controller. Check information on the box or consult your dealer if you are not sure.
- Using batteries other than specified may result in explosion. Dispose of properly, observing environmental protection rules.

Radio transceiver	
Radio protocol	Z-Wave (500 series chip)
Frequency band	868.4 or 869.8 MHz EU 921.4 or 919.8 MHz ANZ
Transceiver range	up to 50m outdoors up to 40m indoors (depending on terrain and building structure)
Max. transmit power	6dBm

(*) The transceiver range is strongly influenced by other devices operating at the same frequency with continuous transmission, such as alarms and radio headphones which interfere with the control unit transceiver.

12 PRODUCT DISPOSAL

This product is an integral part of the automation and therefore must be disposed together with the latter.

As in installation, also at the end of product lifetime, the disassembly and scrapping operations must be performed by qualified personnel. This product is made of various types of material, some of which can be recycled while others must be scrapped. Seek information on the recycling and disposal systems envisaged by the local regulations in your area for this product category.

Caution! – some parts of the product may contain pollutant or hazardous substances which, if disposed of into the environment, may cause serious damage to the environment or physical health.

As indicated by the symbol alongside, disposal of this product in domestic waste is strictly prohibited. Separate the waste into categories for disposal, according to the methods envisaged by current legislation in your area, or return the product to the retailer when purchasing a new version.

Caution! – local legislation may envisage serious fines in the event of abusive disposal of this product.



13 DECLARATION OF CONFORMITY

Hereby, Nice S.p.A., declares that the radio equipment type Motion-Control is in compliance with Directive 2014/53/EU.

The full text of the EU declaration of conformity is available at the following internet address: <http://www.niceforyou.com/en/support>



Nice SpA
Oderzo TV Italia
info@niceforyou.com

www.niceforyou.com