

PHILIPS

hue personal wireless lighting

Solo lightstrip

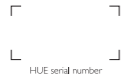

HUE serial number

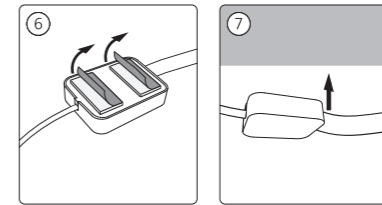
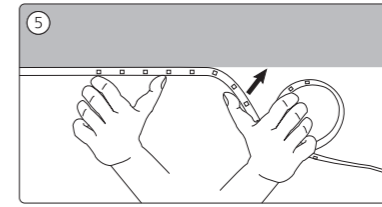
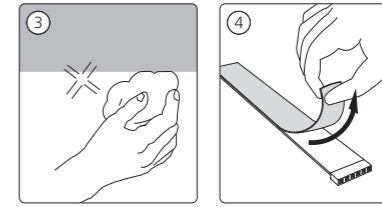
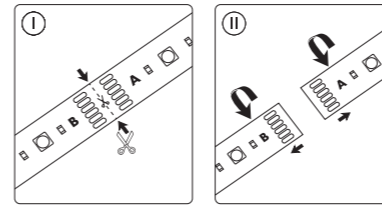
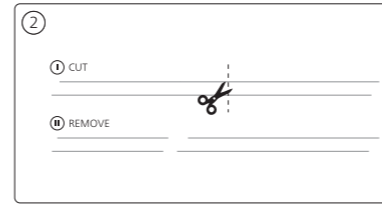
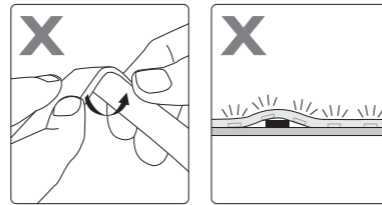
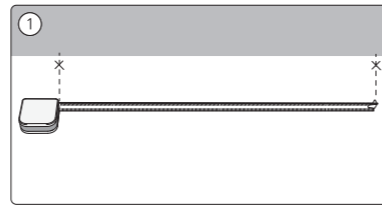
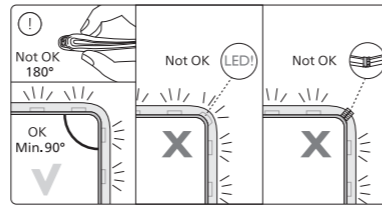
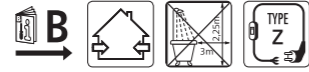
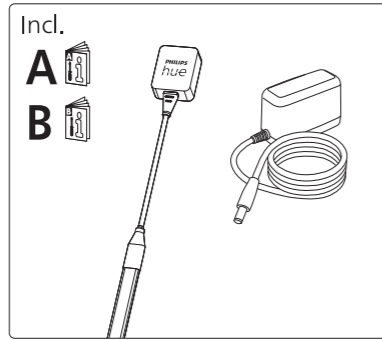

Signify  
I.B.R.S. / C.C.R.I. Numéro 10461  
5600 VB Eindhoven,  
the Netherlands  
00800-74454775

© 2024 Signify Holding  
All rights reserved

Last update: 02/2024

www.philips-hue.com

442296457571



User manual  
Benutzerhandbuch  
Notice d'emploi  
Manual de usuario  
Manual do usuário  
Manuale d'uso

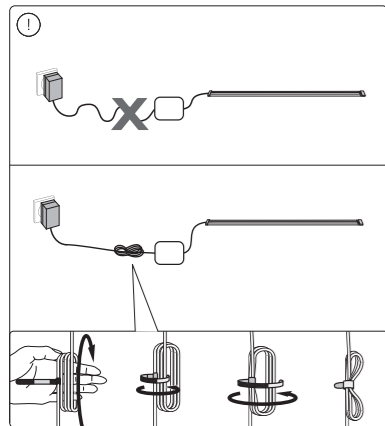
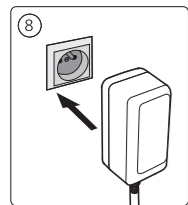

To connect your new Hue luminaire, select the installation instruction (A or B) that is applicable for you.  
**Discover**  
For more information visit [philips-hue.com](http://philips-hue.com)

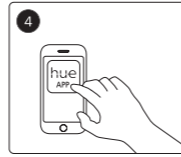
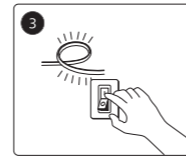
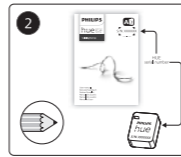
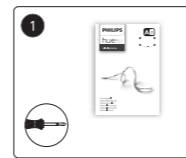
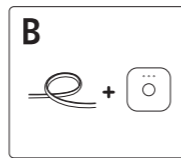
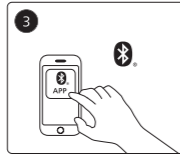
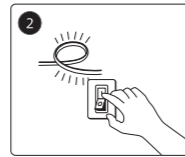
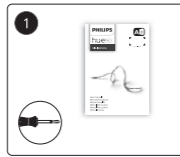
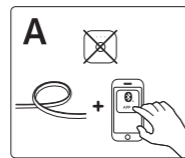

**DE**  
Zum Verbinden Ihrer neuen Hue-Leuchte wählen Sie die für Ihre Situation zutreffende Installationsanweisung (A oder B)  
**Entdecken**  
Weitere Informationen finden Sie unter [www.philips-hue.com](http://www.philips-hue.com)

**FR**  
Pour raccorder votre nouveau luminaire, sélectionnez la consigne d'installation (A ou B) qui s'applique à vous.  
**Découvrez**  
Pour plus d'informations, rendez-vous sur [www.philips-hue.com](http://www.philips-hue.com)

**ES**  
Para conectar su nueva luminaria Hue, seleccione la instrucción de instalación (A o B) que sea aplicable en su caso.  
**Descubrir**  
Para obtener más información, visita [www.philips-hue.com](http://www.philips-hue.com)

**PT**  
Para ligar a sua nova luminária Hue, selecione as instruções de instalação (A ou B) que se aplicam a si.  
**Descobrir**  
Para mais informações, visite [www.philips-hue.com](http://www.philips-hue.com)

**IT**  
Per collegare il nuovo apparecchio per l'illuminazione Hue White, selezionare le istruzioni di installazione (A o B) adatte alle proprie esigenze.  
**Scoperta**  
Per ulteriori informazioni, visita il sito Internet [www.philips-hue.com](http://www.philips-hue.com)

**NL**  
Kies de installatie-instructies (A of B) die voor jou van toepassing zijn om je nieuwe Hue armatuur aan te sluiten.  
**Ontdek**  
Meer informatie vindt u op [www.philips-hue.com](http://www.philips-hue.com)

**EL**  
Για να συνδέσετε το νέο φωτιστικό Hue, επιλέξτε τις οδηγίες εγκατάστασης (A ή B) που ισχύουν για το δικό σας προϊόν.  
Ανακαλύψτε  
Για περισσότερες πληροφορίες, επισκεφθείτε την τοποθεσία [www.philips-hue.com](http://www.philips-hue.com)

**PL**  
Aby podłączyć nową oprawę oświetleniową Hue, wybierz odpowiednią instrukcję instalacji (A lub B).  
**Odkrywanie**  
Więcej informacji można znaleźć na stronie internetowej [www.philips-hue.com](http://www.philips-hue.com)

**CZ**  
Před připojením svítidla Hue zvolte montážní pokyny (A nebo B) relevantní pro váš systém.  
**Nabídka**  
Více informací naleznete na [www.philips-hue.com](http://www.philips-hue.com)

**HU**  
Az új Hue lámpatestet csatlakoztatásához válassza ki a körülményeknek megfelelő telepítési útmutatót (A vagy B).  
**Fedezze fel**  
A további tudnivalók a [www.philips-hue.com](http://www.philips-hue.com) oldalon olvashatók

**DA**  
Tilslut det nye Hue White-armatur som angivet i den relevante installationsanvisning (A eller B).  
**Opdage**  
Du kan finde flere oplysninger på [www.philips-hue.com](http://www.philips-hue.com)

**SV**  
Vid anslutning av en ny Hue-armatur väljer du den installationsanvisning (A eller B) som gäller för dig.  
**Upptäck**  
Mer information finns på [www.philips-hue.com](http://www.philips-hue.com)

**NO**  
For å koble til den nye Hue-lysmatøren, velg installeringsinstruksjonen (A eller B) som gjelder for deg.  
**Bli kjent**  
Du finner mer informasjon ved å gå til [www.philips-hue.com](http://www.philips-hue.com)

**FI**  
Kytke uusi Hue-valaisin valitsemalla soveltuva asennusohje (A tai B).  
**Tutustu**  
Lisätietoja on osoitteessa [www.philips-hue.com](http://www.philips-hue.com)  
**SK**  
Ak chcete pripojiť svoje nové svietidlo Hue, vyberte montážne pokyny (A alebo B), ktoré sa naň vzťahujú.  
**Objavte**  
Ďalšie informácie ziskate na lokalite [www.philips-hue.com](http://www.philips-hue.com)